

# **BASIC PRINCIPLES**

of Non-Contact  
Temperature Measurement



## Content

	Site
Physical Basics .....	4 – 9
Emissivity and Temperature Measurement .....	10 – 14
Optics, Sighting Techniques and Electronics .....	15 – 18
Infrared Thermometers and Applications .....	19 – 24
Thermal Imagers and Applications .....	25 – 31
Literature .....	32
Appendix: Glossary .....	33
Appendix: Emissivity Table .....	34 – 38
Appendix: Selection Criteria for IR temperature measurement devices .....	39

# Physical Basics

## Physical Basics

With our eyes we see the world in visible light. Whereas visible light fills only a small part of the radiation spectrum, the invisible light covers most of the remaining spectral range. The radiation of invisible light carries much more additional information.

### The Infrared Temperature Measurement System

Each body with a temperature above the absolute zero ( $-273,15\text{ °C} = 0\text{ Kelvin}$ ) emits an electromagnetic radiation from its surface, which is proportional to its intrinsic temperature. A part of this so-called intrinsic radiation is infrared radiation, which can be used to measure a body's temperature. This radiation penetrates the atmosphere. With the help of a lens (input optics) the beams are focused on a detector element, which generates an electrical signal proportional to the radiation. The signal is amplified and, using successive digital signal processing, is transformed into an output signal proportional to the object temperature. The measuring value

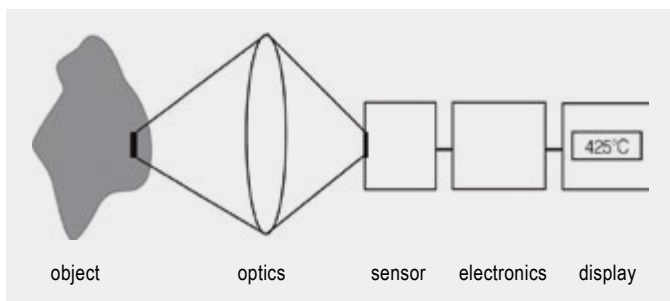

Infrared System

may be shown in a display or released as analog output signal, which supports an easy connection to control systems of the process management.

The advantages of non-contact temperature measurement are clear – it supports:

- temperature measurements of moving or overheated objects and of objects in hazardous surroundings
- very fast response and exposure times
- measurement without inter-reaction, no influence on the measuring object
- non-destructive measurement
- long lasting measurement, no mechanical wear



William Herschel (1738–1822)



### Discovery of the Infrared Radiation

Searching for new optical material William Herschel by chance found the infrared radiation in 1800. He blackened the peak of a sensitive mercury thermometer. This thermometer, a glass prism that led sun rays onto a table made his measuring arrangement. With this, he tested the heating of different colors of the spectrum. Slowly moving the peak of the blackened thermometer through the colors of the spectrum, he noticed the increasing temperature from violet to red. The temperature rose even more in the area behind the red end of the spectrum. Finally he found the maximum temperature far behind the red area. Nowadays this area is called “infrared wavelength area”.

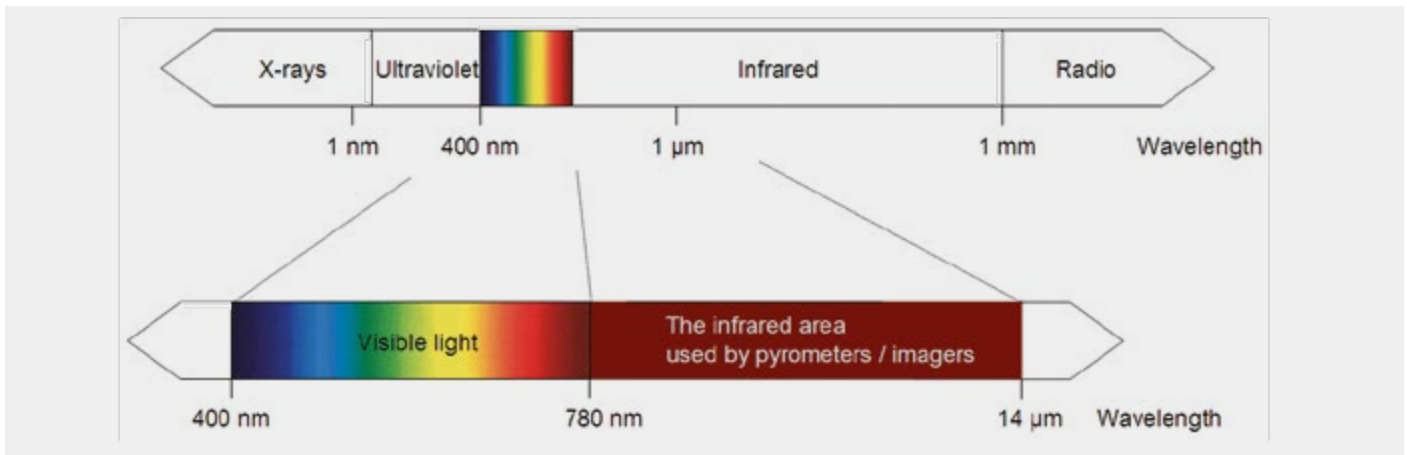

The electromagnetic spectrum with the infrared area used by pyrometers.

## The Electromagnetic Radiation Spectrum

A spectrum in the physical sense is the intensity of a mixture of electromagnetic waves as the function of the wavelength or frequency. The electromagnetic radiation spectrum covers a wavelength area of about 23 decimal powers and varies from sector to sector in origin, creation and application of the radiation. All types of electromagnetic radiation follow similar principles of diffraction, refraction, reflection and polarisation. Their expansion speed corresponds to the light speed under normal conditions: The result of multiplying wavelength with frequency is constant:

$$\lambda \cdot f = c$$

The infrared radiation covers a very limited part in the whole range of the electromagnetic spectrum: It starts at the visible range of about 0.78 μm and ends at wavelengths of approximately 1000 μm.

Wavelengths ranging from 0.7 to 14 μm are important for infrared temperature measurement. Above these wavelengths the energy level is so low, that detectors are not sensitive enough to detect them.

## Physical Basics

In about 1900 Planck, Stefan, Boltzmann, Wien and Kirchoff precisely defined the electromagnetic spectrum and established qualitative and quantitative correlations for describing the infrared energy.

## The Black Body

A black body is a radiator, which absorbs all incoming radiation. It shows neither reflection nor transmissivity.

$$\alpha = \varepsilon = 1 \quad (\alpha \text{ absorption, } \varepsilon \text{ emissivity})$$

A black body radiates the maximum energy possible at each wavelength. The concentration of the radiation does not depend on angles. The black body is the basis for understanding the physical fundamentals of non-contact temperature measurement and for calibrating the infrared thermometers.

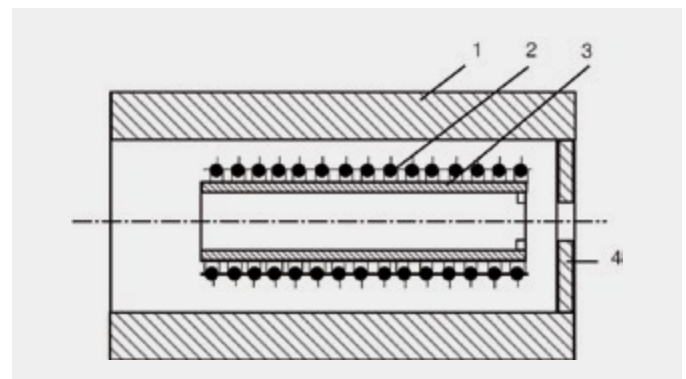

Drawing of a black body:

1 – ceramic conduit, 2 – heating, 3 – conduit made from Al<sub>2</sub>O<sub>3</sub>, 4 – aperture

A black body radiates the maximum energy possible at each wavelength. The concentration of the radiation does not depend on angles. The black body is the basis for understanding the physical fundamentals of non-contact temperature measurement and for calibrating the infrared thermometers.

The construction of a black body is simple. A thermal hollow body has a small hole at one end. If the body is heated and reaches a certain temperature, inside the hollow room a balanced temperature spreads. The hole emits ideal black radiation of this temperature. For each temperature range and

# Physical Basics

application purpose the construction of these black bodies depends on material and the geometric structure. If the hole is very small compared to the surface as a whole, the interference of the ideal state is very small. If you point the measuring device on this hole, you can declare the temperature emitting from inside as black radiation which you can use for calibrating your measuring device. In reality simple arrangements use surfaces, which are covered with pigmented paint and show absorption and emissivity values of 99 % within the required wavelength range. Usually this is sufficient for calibrations of real measurements.

## Radiation Principles of a Black Body

The radiation law by Planck shows the basic correlation for non-contact temperature measurements: It describes the spectral specific radiation  $M_{\lambda S}$  of the black body into the half space depending on its temperature  $T$  and the wavelength  $\lambda$ .

$$M_{\lambda S} = \frac{2\pi hc^2}{\lambda^5} \frac{1}{e^{hc/\lambda kT} - 1} = \frac{C_1}{\lambda^5} \frac{1}{e^{C_2/\lambda T} - 1}$$

$C$  light speed

$C_1$   $3,74 \cdot 10^{-16} \text{ W m}^2$

$C_2$   $1,44 \cdot 10^{-2} \text{ K m}$

$h$  Planck's constant

The following illustration shows the graphic description of the formula depending on  $\lambda$  with different temperatures as parameters.

With rising temperatures the maximum of the spectral specific radiation shifts to shorter wavelengths. As the formula is very abstract it cannot be used for many practical applications. But, you may derive various correlations from it. By integrating the spectral radiation intensity for all wavelengths from 0 to infinite you can obtain the emitted radiation value of the body as a whole. This correlation is called Stefan-Boltzmann-Law.

$$M_{\lambda S} = \sigma \cdot T^4 \text{ [Watt m}^2\text{]} \quad \sigma = 5,67 \cdot 10^{-8} \text{ WM}^{-2} \text{ K}^{-4}$$

The entire emitted radiation of a black body within the overall wavelength range increases proportional to the fourth power of its absolute temperature. The graphic illustration of Planck's law also shows, that the wavelength, which is used to generate the maximum of the emitted radiation of a black body, shifts when temperatures change. Wien's displacement law can be derived from Planck's formula by differentiation.

$$\lambda_{\max} \cdot T = 2898 \text{ } \mu\text{m} \cdot \text{K}$$

The wavelength, showing the maximum of radiation, shifts with increasing temperature towards the range of short wavelengths.

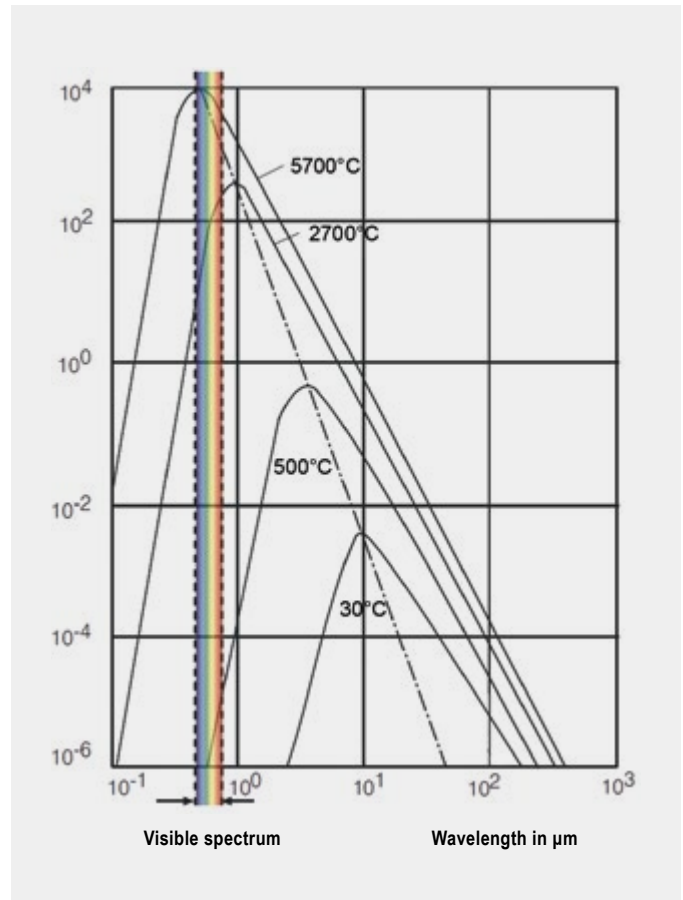

Spectral specific radiation  $M_{\lambda S}$  of the black body depending on the wavelength

## The Grey Body

Only few bodies meet the ideal of the black body. Many bodies emit far less radiation at the same temperature. The emissivity  $\epsilon$  defines the relation of the radiation value in real and of the black body. It is between zero and one. The infrared sensor receives the emitted radiation from the object surface, but also reflected radiation from the surroundings and perhaps penetrated infrared radiation from the measuring object:

$$\epsilon + \rho + \tau = 1$$

$\epsilon$  emissivity

$\rho$  reflection

$\tau$  transmissivity

Most bodies do not show transmissivity in infrared, therefore the following applies:

$$\epsilon + \rho = 1$$

This fact is very helpful as it is much easier to measure the reflection than to measure the emissivity.

## Construction and Operation of Infrared Thermometers

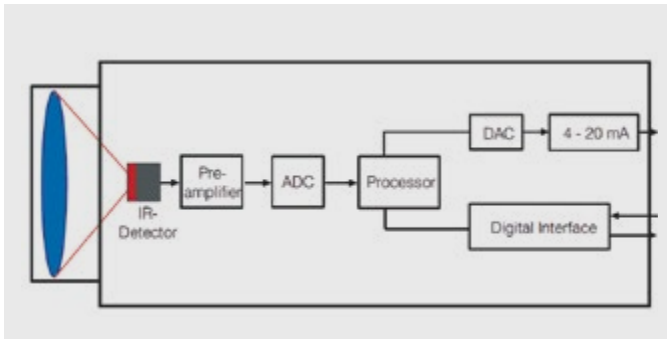

Blockschaltbild eines Infrarot-Thermometers

The illustration shows the general construction of an infrared thermometer. With the help of input optics the emitted object radiation is focused onto an infrared detector. The detector generates a corresponding electrical signal which then is amplified and may be used for further processing. Digital signal processing transforms the signal into an output value proportional to the object temperature. The temperature result is either shown on a display or may be used as analog signal for further processing.

In order to compensate influences from the surroundings a second detector catches the temperature of the measuring device and of his optical channel, respectively. Consequently, the temperature of the measuring object is mainly generated in three steps:

1. Transformation of the received infrared radiation into an electrical signal
2. Compensation of background radiation from thermometer and object
3. Linearization and output of temperature information

Besides the displayed temperature value, the thermometers also support linear outputs such as 0/4–20 mA, 0–10 V and thermocouple elements, which allow an easy connection to control systems of the process management. Furthermore, the most of the presently used infra-red thermometers offer digital interfaces (USB, RS232, RS485) for further digital signal processing and in order to be able to have access to the device parameters.

## Infrared Detectors

The most important element in each infrared thermometer is the radiation receiver, also called detector. There are two main groups of infrared detectors.

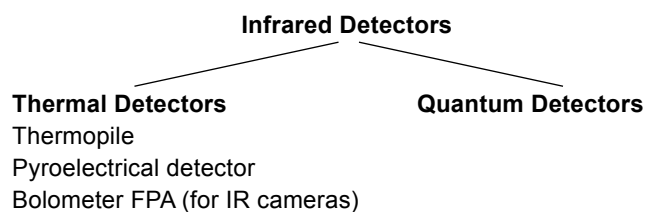

# Physical Basics

## Thermal Detectors

In these detectors the temperature of the sensitive element varies because of the absorption of electromagnetic radiation. This leads to a modified property of the detector, which depends on temperature. This change of the property will be electrically analysed and used as a standard for the absorbed energy.

### Radiation Thermocouple Elements (Thermopiles)

If the joint between two wires of different metallic material heats up, the thermoelectrical effect results in an electrical voltage. The contact temperature measurement has been using this effect for a long time with the help of thermocouple elements. If the connection is warm because of absorbed

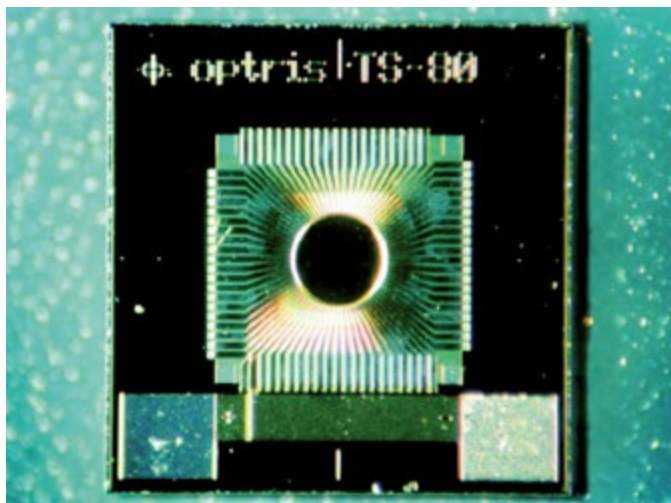

Thermopile TS80

radiation, this component is called radiation thermocouple. The illustration shows thermocouples made of bismuth/antimony which are arranged on a chip round an absorbing element. In case the temperature of the detector increases, this results in a proportional voltage, which can be caught at the end of the bond isles.

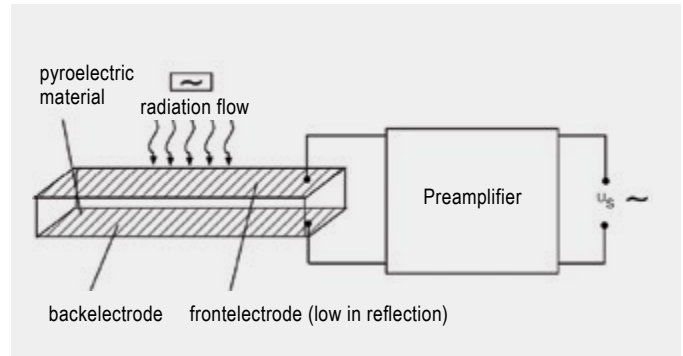

Construction of a pyroelectric detector

## Pyroelectric Detectors

The illustration shows the common construction of a pyroelectric detector. This sensitive element consists of pyroelectric material with two electrodes. The absorbed infrared radiation results in a changed temperature of the sensitive element which leads to a changed surface loading due to the pyroelectric effect. The so created electric output signal is processed by a preamplifier.

Due to the nature of how the loading is generated in the pyroelectric element the radiation flow has to be continuously and alternately interrupted. The advantage of the frequency selective preamplifying is a better signal to noise ratio.

## Bolometers

Bolometers use the temperature dependency of the electric resistance. The sensitive element consists of a resistor, which changes when it absorbs heat. The change in resistance leads to a changed signal voltage. The material should have a high temperature factor of the electrical resistance in order to work with high sensitivity and high specific detectivity. Bolometers which work at room temperature use the temperature coefficient of metallic resistors (e.g. black layer and thin layer bolometer) as well as of semiconductor resistors (e.g. thermistor bolometers).

Nowadays infrared imagers are based on the following technological developments:

The semiconductor technology replaces mechanical scanners. FPA's (Focal Plane Arrays) are produced on the basis of thin layer bolometers. For that purpose VOX (Vanadium oxide) or amorphous silicon are used as alternative technologies. These technologies significantly improve the price-performance ratio. Today, common detector sizes are 160x120, 320x240 and 640x480 pixels



## Quantum Detectors

The decisive difference between quantum detectors and thermal detectors is their faster reaction on absorbed radiation. The mode of operation of quantum detectors is based on the photo effect. The striking photons of the infrared radiation lead to an increase of the electrons into a higher energy level inside the semiconductor material. When the electrons fall back an electric signal (voltage or power) is generated. Also a change of the electric resistance is possible. These signals can be analysed in an exact way. Quantum detectors are very fast (ns bis  $\mu$ s).

The temperature of the sensitive element of a thermal detector changes relatively slowly. Time constants of thermal detectors are usually bigger than time constants of quantum detectors. Roughly approximated one can say that time constants of thermal detectors can be measured in Milliseconds whereas time constants of quantum detectors can be measured in Nanoseconds or even Microseconds.

Despite of the fast development on the field of quantum detectors there are lots of applications, where thermal detectors are preferably used. That is why they are equally positioned with the quantum detectors.

### Transformation of Infrared Radiation into an Electrical Signal and Calculation of the Object Temperature

As per the Stefan-Boltzmann law the electric signal of the detector is as follows:

$$U \sim \varepsilon T_{obj}^4$$

As the reflected ambient radiation and the self radiation of the infrared thermometer is to be considered as well, the formula is as follows:

$$U = C \cdot [\varepsilon T_{obj}^4 + (1 - \varepsilon) \cdot T_{amb}^4 - T_{pyr}^4]$$

$U$	detector signal
$T_{obj}$	object temperature
$T_{amb}$	temperature of background radiation
$T_{pyr}$	temperature of the device
$C$	device specific constant

$$\rho = 1 - \varepsilon \quad \text{Reflexionsgrad des Objektes}$$

As infrared thermometers do not cover the wavelength range as a whole, the exponent  $n$  depends on the wavelength  $\lambda$ . At wavelengths ranging from 1 to 14  $\mu$ m.

$n$  is between 17 and 2 (at long wavelengths between 2 and 3 and at short wavelengths between 15 and 17).

$$U = C \cdot [\varepsilon T_{obj}^n + (1 - \varepsilon) \cdot T_{amb}^n - T_{pyr}^n]$$

Thus the object temperature is determined as follows:

$$T_{obj} = \sqrt[n]{\frac{U - C \cdot T_{amb}^n + C \cdot \varepsilon T_{amb}^n + C \cdot T_{pyr}^n}{C \varepsilon}}$$

The results of these calculations for all temperatures are stored as curve band in the EEPROM of the infrared thermometer. Thus a quick access to the data as well as a fast calculation of the temperature are guaranteed.

## Emissivity

The formula show that the emissivity  $\varepsilon$  is of central significance, if you want to determine the temperature with radiation measurement. The emissivity stands for the relation of thermal radiations, which are generated by a grey and a black body at the same temperature. The maximum emissivity for the black body is 1. A grey body is an object, which has the same emissivity at all wavelengths and emits less infrared radiation than a black radiator ( $\varepsilon < 1$ ). Bodies with emissivities, which depend on the temperature as well as on the wavelength, are called non grey or selective bodies (e.g. metals).

see emissivity table starting page 34

# Emissivity and Temperature Measurement

## Emissivity and temperature measurement

Emissivity is a key factor for the accurate measurement of temperatures. It depends on various influences and must be adjusted according to the application.

The emissivity depends on the material, its surface, temperature, wavelength and sometimes on the measuring arrangement. Many objects consisting of nonmetallic material show a high and relatively constant emissivity independent from their surface consistency, at least in longwave ranges.

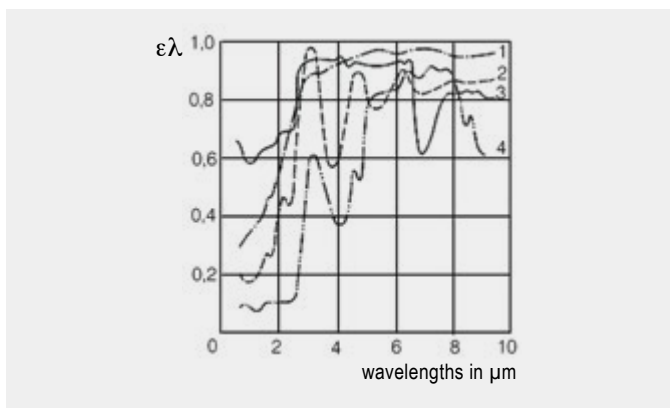

Spectral emissivity of some materials: 1 Enamel, 2 Plaster, 3 Concrete, 4 Chamotte

Generally metallic materials show a low emissivity, which strongly depends on the surface consistency and which drop in higher wavelengths.

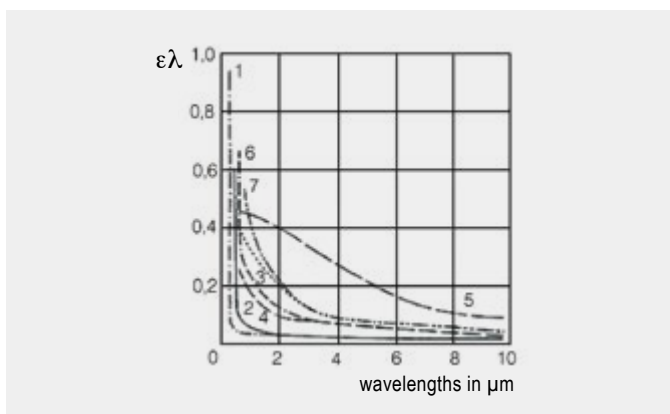

Spectral emissivity of metallic materials: 1 Silver, 2 Gold, 3 Platin, 4 Rhodium, 5 Chrome, 6 Tantalum, 7 Molybdenum

## Temperature Measurement of Metallic Materials

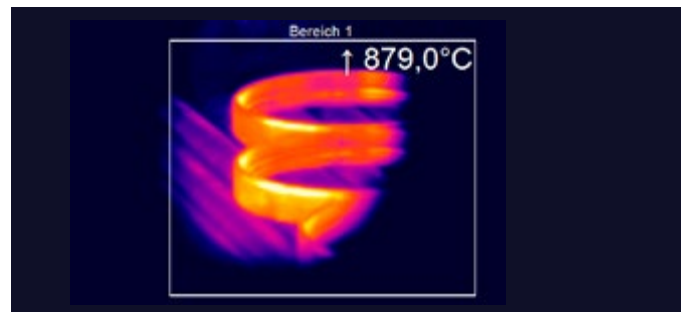

Measurement on bearing rings during hardening process

This may result in varying measuring results. Consequently, already the choice of the infrared thermometer depends on the wavelength and temperature range, in which metallic materials show a relatively high emissivity. For metallic materials the shortest possible wavelength should be used, as the measuring error increases in correlation to the wavelength. The optimal wavelength for metals ranges with 0.8 to 1.0 μm for high temperatures at the limit of the visible area.

Additionally, wavelengths of 1.6 μm, 2.2 μm and 3.9 μm are possible.

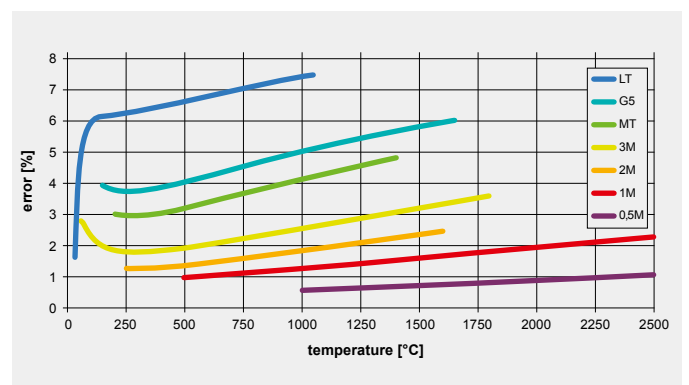

Measurement error of 10 % as result of wrongly adjusted emissivity and in dependence on wavelength and object temperature (LT: 8 – 14 μm; GS: 5 μm; MT: 3.9 μm; 3M: 2.3 μm; 2M: 1.6 μm; 1M: 1.0 μm); 0.5M: 525 nm.

Further information in our High Temperature Applications brochure:  
<http://www.optris.com/metal>

### Temperature Measurement of Plastics

Transmissivities of plastics vary with the wavelength. They react inversely proportional to the thickness, whereas thin materials are more transmissive than thick plastics. Optimal measurements can be carried out with wavelengths, where transmissivity is almost zero independent from the thickness. Polyethylene, polypropylen, nylon and polystyrene are non-transmissive at 3.43 µm, polyester, polyurethane, teflon, FEP and polyamide are non-transmissive at 7.9 µm. For thicker and pigmented films wavelengths between 8 and 14 µm will do.

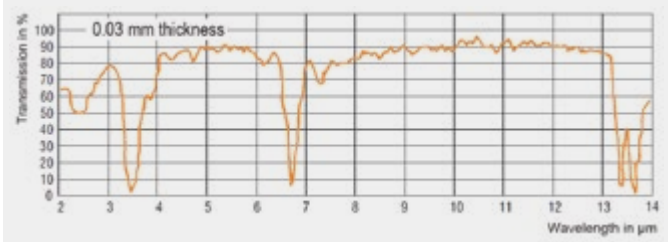

Spectral permeability of plastics made from polyethylene

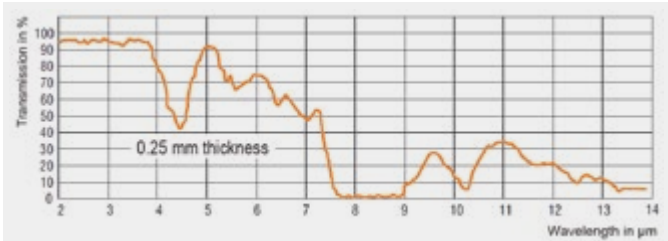

Spectral transmissivity of plastic layers made of polyester

The manufacturer of infrared thermometers can determine the optimal spectral range for the temperature measurement by testing the plastics material. The reflection is between 5 and 10 % for almost all plastics.

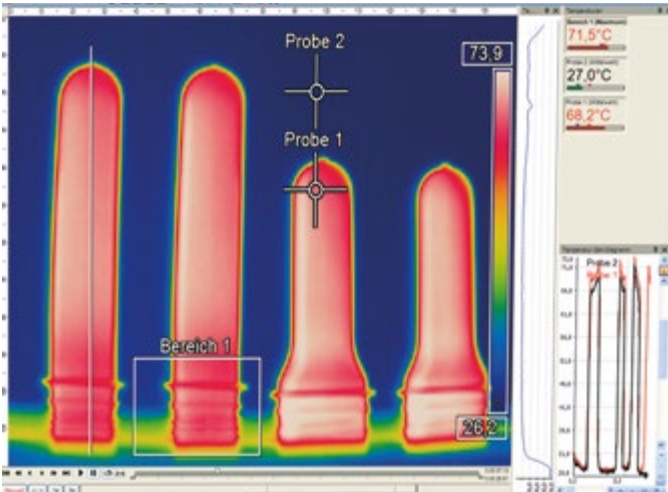

Detailed analysis of preforms during bottle manufacturing

Further information in our plastics applications overview: <http://www.optris.com/plastics>

### Temperature Measurement of Glass

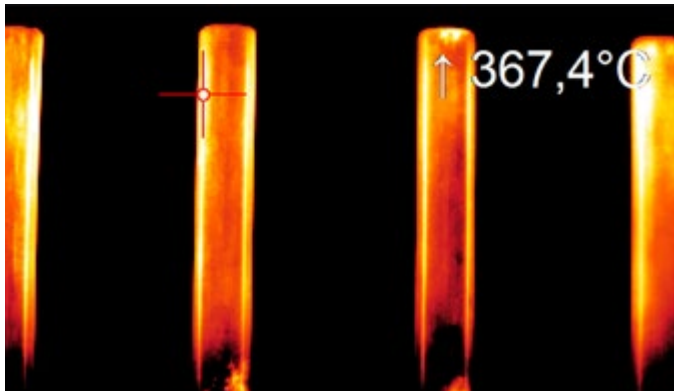

Hot spot detection on glass tube preforms

If you measure temperatures of glass with IR thermometers or the special IR camera optris PI G7 it implies that you take care of reflection and transmissivity. A careful selection of the wavelength facilitates measurements of the glass surface as well as of the deeper layers of the glass. Wavelengths of 1.0 µm, 2.2 µm or 3.9 µm are appropriate for measuring deeper layers whereas 5 µm are recommended for surface measurements. If temperatures are low, you should use wavelengths between 8 and 14 µm in combination with an emissivity of 0.85 in order to compensate reflection. For this purpose a thermometer with short response time should be used as glass is a bad heat conductor and can change its surface temperature quickly.

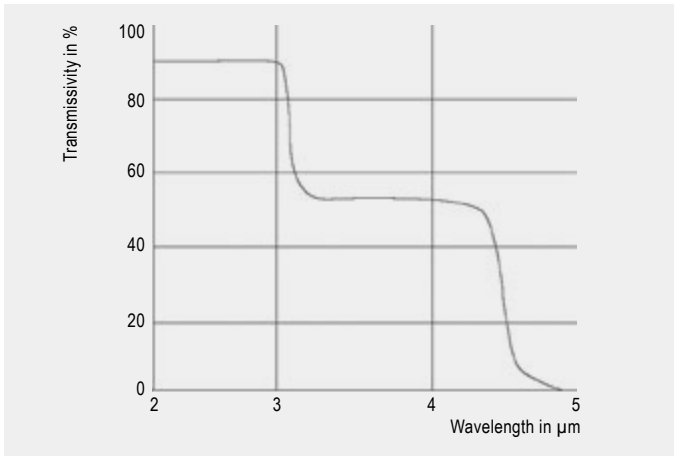

Spectral transmissivity of glass

Further information in our glass applications overview: <http://www.optris.com/temperature-monitoring-glass-industry>

# Emissivity and Temperature Measurement

## Influence from the Surroundings

The illustration shows that the transmissivity of air strongly depends on the wavelength. Strong flattening alternates with areas of high transmissivity – the so-called atmospheric windows. The transmissivity in the longwave atmospheric window (8–14  $\mu\text{m}$ ) is constantly high whereas there are measurable alleviations by the atmosphere in the shortwave area, which may lead to false results. Typical measuring windows are 1.1 ... 1.7  $\mu\text{m}$ , 2 ... 2.5  $\mu\text{m}$  and 3 ... 5  $\mu\text{m}$ .

Additional influences can arise from heat sources in the environment of the measuring object. To prevent wrong measuring results due to increased ambient temperatures, the infrared thermometer compensates the influence of ambient temperatures beforehand (as e.g. when measuring temperatures of metals in industrial ovens, where the oven walls are hotter than the measuring object). A second temperature sensing head helps to generate accurate measuring results by automatically compensating the ambient temperatures and a correctly adjusted emissivity.

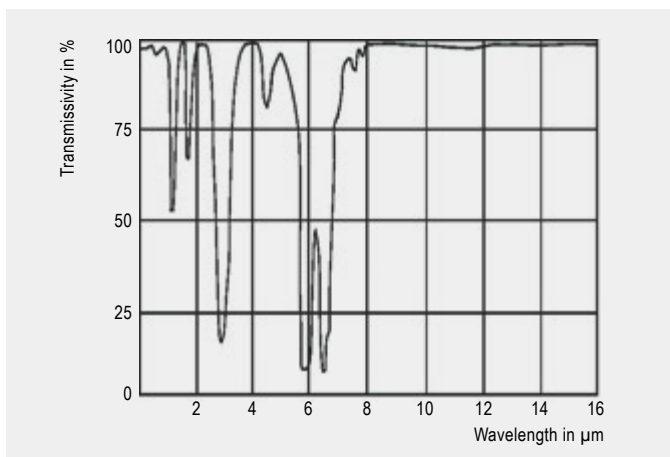

Spectral transmissivity of air (1 m, 32 °C, 75 % r. F.)

Dust, smoke and suspended matter in the atmosphere can pollute the optics and result in false measuring data. Here air purge collars (which are installed in front of the optics with compressed air) help to prevent deposition of suspended matter in front of the optics. Accessories for air and water cooling support the use of infrared thermometers even in hazardous surroundings.

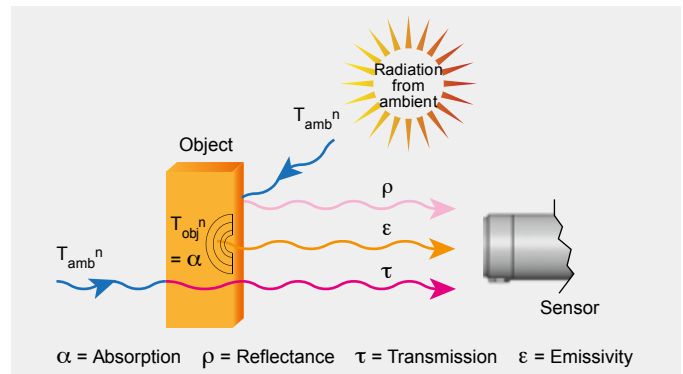

Compensating ambient influences

## Experimental Determination of Emissivities

In the addendum you will find emissivity dates for various materials from technical literature and measurement results. There are different ways to determine the emissivity.

**Method 1:** With the help of a thermocouple:

With the help of a contact probe (thermocouple) an additional simultaneous measurement shows the real temperature of an object surface. Now the emissivity on the infrared thermometer will be adapted so that the temperature displayed corresponds to the value shown with the contact measurement. The contact probe should have good temperature contact and only a low heat dissipation.

**Method 2:** Creating a black body with a test object from the measuring material:

A drilled hole (drilling depth  $\leq \frac{1}{3}$  in thermal conducting material reacts similar to a black body with an emissivity near 1. It is necessary to aim at the ground of the drilled hole because of the optical features of the infrared device and the measuring distance. Then the emissivity can be determined.

**Method 3:** With a reference emissivity:

A plaster or band or paint with a known emissivity, which is put onto the object surface, helps to take a reference measurement. With an emissivity thus adjusted on the infrared thermometer the temperature of the plaster, band or paint can be taken. Afterwards the temperature next to this surface spot will be taken, while simultaneously the emissivity will have to be adjusted until the same temperature is displayed as is measured beforehand on the plaster, band or paint. Now the emissivity is displayed on the device.

## Calibration of infrared thermometers <sup>[1] [2]</sup>

Infrared thermometers are calibrated with the help of reference radiation sources, so called black bodies. These radiant sources are able to produce different temperatures with a high stability (see also section The Black Body).

Knowing the exact value of the radiation temperature is essential for the calibration process. It can be measured by either using a contact thermometer (in combination with the determination of the emissivity) or a transfer standard infrared thermometer. This value can then be used to determine the device constant for an initial calibration of the infrared sensors. In order to conduct a post-calibration by customers or local calibration facilities, the calibration temperature should be near the temperatures which occur at the respective applications.

Optris makes use of a transfer standard radiation thermometer LS-PTB (see figure) to measure the radiation temperature of a reference source. The LS-PTB is based on the portable IR thermometer optris® LS. The LS-PTB needs to be traceable to the international temperature scale from 1990 (ITS-90). Thus, it is calibrated by the PTB (German national metrology institute) on a regular basis.

ITS-90 is a very good approximation of thermodynamic temperature. It is based on 17 well-reproducible fixed values such as melting points of highly pure metals. Within the framework of ITS-90 the LS-PTB is compared to national temperature standards from the PTB. This comparison within a closed chain of comparative measurements with a known uncertainty in measurement takes place on a regular basis.



certificates of Physikalisch-Technische Bundesanstalt (PTB)

Based on the LS-PTB, Optris produces the LS-DCI as a high-precision reference IR thermometer for its customers. The DCI units are produced with pre-selected components supporting a high stability of measurement. In combination with a dedicated calibration at three calibration points the LS-DCI achieves a higher accuracy at these reference points.



optris® LS-PTB

# Emissivity and Temperature Measurement



Automated calibration stations at Optris GmbH

The optics of an IR thermometer is described by the distance-to-spot-ratio (D:S). Depending on the quality of the optics a certain amount of radiation is also received from sources outside the specified measurement spot. The maximum value here equals the radiation emitted by a hemispheric radiant source. The respective signal change in correlation with a resize of the radiation source is described by the Size-of-source effect (SSE).

As a result of this correlation all manufacturers of IR thermometers use accurately defined geometries for the calibration of their units; meaning depending on the aperture of the radiation source (A) a distance (a) between the IR thermometer and the reference source is defined. Thus, the value specified in datasheets and technical documentation as measurement field is in general a certain defined percentage of this radiation maximum – values of 90 % or 95 % are common.

Optris GmbH has up-to-date in-house laboratories which fulfill the mandatory requirements for calibration stations. When issuing calibration certificates it is not only the laboratory temperature and humidity that is documented but also the measurement distance and source diameter (calibration geometry).

## Optics, Sighting Techniques and Electronics

### Construction of the Infrared Thermometers

Infrared thermometers have various configurations and designs, which differ in optics, electronics, technology, size and housing. Nevertheless, the way of how the signals are processed is the same: It always starts with an infrared signal and ends with an electronic temperature output signal.

### Optics and Window

An optical system – mostly consisting of lens optics – forms the beginning of the measuring chain. The lens receives the emitted infrared energy from a measuring object and focuses it onto a detector. Measurements based on this technology can only be correct, if the measuring object is bigger in size than the detector spot. The distance ratio describes the size of the measuring spot at a certain distance. It is defined as D:S-ratio: relation of measuring distance to spot diameter. The optical resolution improves with increasing values of the D:S ratio.

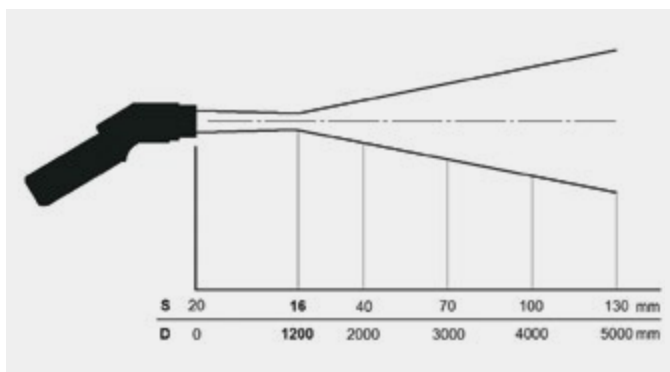

Optical diagram of an infrared sensor

Because of their material infrared optics can be used for a certain range of wavelengths, only. The following illustration shows typical lenses and window materials with their corresponding wavelength for infrared thermometers.

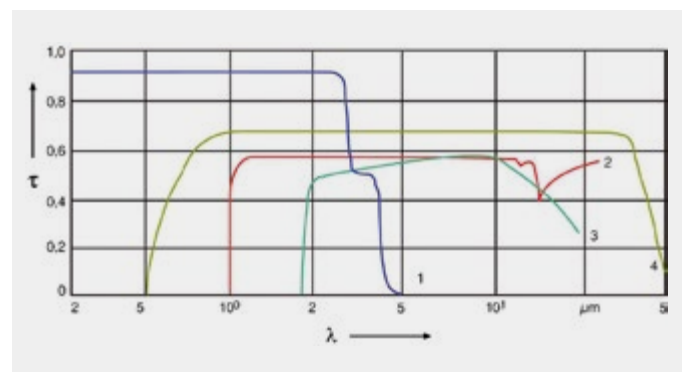

Transmissivity of typical infrared materials (1 mm thick)  
1 Glass, 2 Germanium, 3 Amorphous Silicon, 4 KRS<sub>5</sub>

Some measurements make it necessary to take the temperature through an appropriate measuring window, as in closed reaction containers, ovens or vacuum chambers. The transmissivity of the measuring window should match the spectral sensitivity of the sensor. Quartz crystal fits for high measuring temperatures. Special material like Germanium, AMTIR or Zinkselenid should be used for low temperatures in the spectral range between 8 – 14  $\mu\text{m}$ . Also diameter of the window, temperature conditions and maximum compression balance are important features for the selection of a qualified window material. A window of 25 mm in diameter, which has to resist a compression balance of 1 atmosphere, should be 1.7 mm thick. Window material, which is transparent also in the visible range, might help in order to appropriately adjust the sensor onto the measuring object (e.g. inside the vacuum container).

# Optics, Sighting Techniques and Electronics

The table shows various window materials in a survey.

Window-material / features	Al <sub>2</sub> O <sub>3</sub>	SiO <sub>3</sub>	CaF <sub>2</sub>	BaF <sub>3</sub>	AMTIR	ZnS	ZnSe	KRS <sub>5</sub>
Recommended infrared wavelength in $\mu\text{m}$	1 ... 4	1 ... 2.5	2 ... 8	2 ... 8	3 ... 14	2 ... 14	2 ... 14	1 ... 14
Max. window temperature in $^{\circ}\text{C}$	1800	900	600	500	300	250	250	no info
Transmissivity in visible area	yes	yes	yes	yes	no	yes	yes	yes
Resistiveness against humidity, acids, ammoniac combinations	very good	very good	few	few	good	good	good	good
Appropriate for UHV	yes	yes	yes	yes	no info	yes	yes	yes

Windows with anti reflection coating have a significantly higher transmissivity (up to 95 %). The transmissivity loss can be corrected with the transmissivity setup, in case the manufacturer specified the corresponding wavelength area. If not, it has to be identified with an infrared thermometer and a reference source.

## Latest Trends in Sighting Techniques

New principles of measurement and sighting techniques facilitate an improved and precise use of infrared thermometers. Developments in the field of solid state lasers are adapted for multiple laser arrangements to mark the spot sizes. Thus, the real spot sizes inside the object field are denoted with the help of laser crosshairs techniques. Different products use video camera chips instead of optical sighting systems.

### Development of high-performance optics in combination with cross hair laser sighting technologies

Simple, cost-effective portable infrared thermometers use single point laser aimers in order to distinguish the centre of the spot with a parallax default. With that technique the user has to estimate the spot size with the help of the spot size diagram and the likewise estimated measuring distance.

If the measuring object takes only a part of the measuring spot, temperature rises are only displayed as average value of hot area and ambient cold area. A higher resistance of an electric connection due to a corroded contact results in an unduly heating. Due to small objects and inappropriate big spot sizes, this rise will be shown as a minor heating, only: Thus, potentially dangerous heatings may not be recognized in time.

In order to display spots in their real size, optical sighting systems with a size marking were developed. They allow an exact targeting. As laser pyrometers are significantly easier and safer than contact thermometers, engineers have tried to mark the spot size with laser sighting techniques independently from the distance – according to the distance-spot-size-ratio in the diagram.

Two warped laser beams approximately show the narrowing of the measuring beam and its broadening in longer distances. The diameter of the spot size is indicated by two spots on the outer circumference. Due to the design the angle position of these laser points on the circuit alternates which makes an aiming difficult.

An advancement is the 2015 relaunched video pyrometer, which enables accurate field measuring markers as a result of the simultaneous use of a video module and the cross hair laser sight.

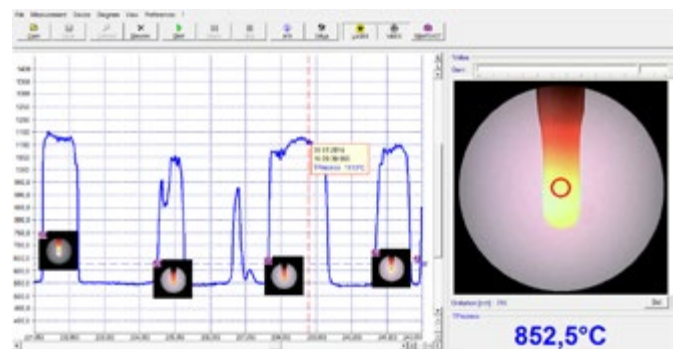

The optris Compact Connect software features extensive adjustment possibilities for the video pyrometer



### The Principle of the Crosshairs

New laser sighting techniques support denoting measuring spots of infrared thermometers as real-size crosshairs, exactly matching the measuring spot in their dimension.

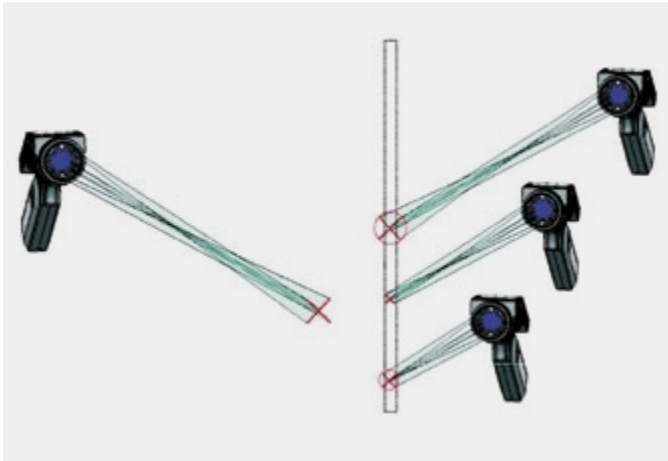

*Infrared thermometer with laser crosshairs for exact spot size marking*

Four laser diodes are arranged in symmetrical order around the infrared optical measuring channel. They are connected to line generators, which create a line of defined length inside the focus distance. The line generators, arranged in pairs, face each other. They overlap the projected laser lines at the focus. That way crosshairs are generated, which exactly display the diameter of the measuring spot. At longer or shorter distances the overlapping is only partly. Thus the user has a changed line length and with this changed measuring crosshairs. With the help of this technology the precise dimensions of a measuring spot can be denoted for the first time. This development improves the practical use of products with good optical performance.

### Switching to Close Focus Mode

Common applications in electrical maintenance and industrial quality control imply optimal measuring distances of about 0.75 to 2.5 metres. Additionally, it is often necessary to measure distinctly smaller objects at shorter distances. Because of that engineers designed products, which allow focusing within certain limits. Still, they had not succeeded in creating spot sizes smaller than 1 mm.

New products apply a technology which uses two-lens optics: Similar to digital cameras, the inner lens position can be switched digitally into focusing onto very small spot sizes. The result is a very small spot size, but only at a constant distance. If the distance grows smaller or longer between measuring spot and infrared thermometer, the measuring spot increases in size. Two laser beams crossing each other create a laser point diameter of 1 mm at the smallest spot size position. They help to show optimal distance as well as spot size. The illustration shows the optical system of a modern infrared thermometer: The lens position is selectable and simultaneously various laser sighting systems support a real-size display of the measuring spot.

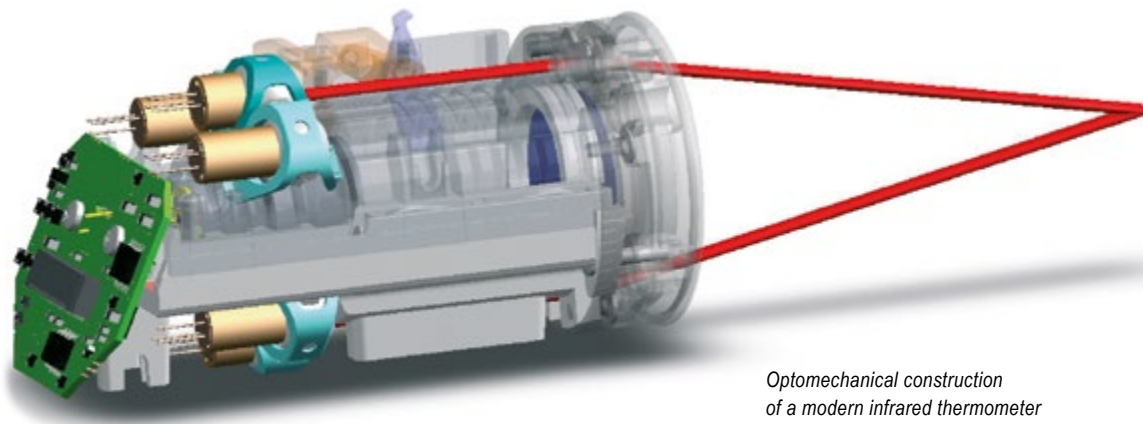

*Optomechanical construction of a modern infrared thermometer*

# Optics, Sighting Techniques and Electronics

## Electronics

### Displays, Outputs and Interfaces

The electronics of the infrared thermometer linearise the output signal of the detector in order to generate a linear power signal 0/4–20 mA or voltage signal 0–10 V. The portable thermometers show this signal as a temperature result on the LCD displays. Additionally some of the portable units as well as online sensors offer various outputs and interfaces for further signal processing.

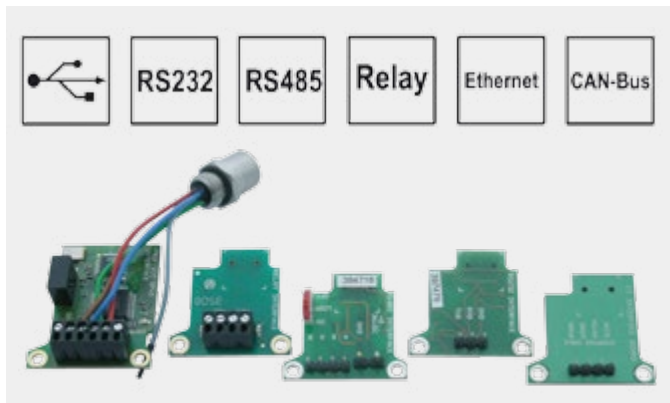

Outputs and interfaces (analog and digital).

As an example: pluggable, digital interface modules of electronic box

## Examples for Outputs and Interfaces of Infrared Thermometers

The importance of industrial field bus systems increases more and more. They allow more flexibility and less cabling and wiring efforts. If the manufacturer plans a change in products, the sensor parameters (emissivity, measuring range or limiting value) can be adjusted remotely.

Consequently, a continuous process control and management is guaranteed even in hazardous surroundings and with a minimum of labor. If a failure occurs, e.g. cable interruptions, drop-out of components, automatically an error message appears.

A further advantage of infrared thermometers with digital interface is the possibility to carry out field calibrations with calibration software of the manufacturer.

The output interfaces of infrared thermometers may be directly connected with PC, laptop, measuring data printer. PC software allows customer oriented graphics and tables.

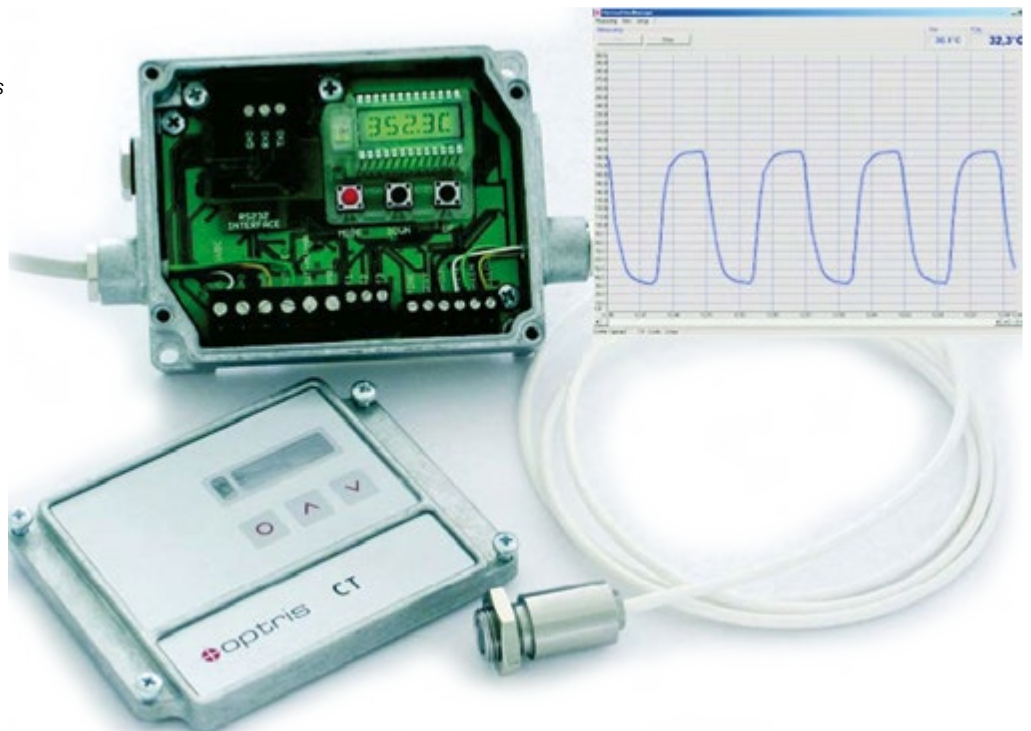

# Infrared Thermometers and Applications

Noncontact temperature measurement with infrared thermometers is a qualified method of controlling, monitoring and managing process temperatures and of preventive maintenance of machines and facilities. Portable infrared thermometers or infrared online sensors, additionally split into point and image measuring products, can be selected depending on the application.



## Portable Infrared Thermometers

Generally portable infrared thermometers are used to verify critical parts quickly and easily, for example for preventive maintenance and inspection of electrical facilities, rotating machines as well as a tool for diagnosis for heating, ventilation and air conditioning systems and for the quick analysis of cars.

The infrared thermometers are also designed for applications under difficult industrial conditions. They might be used inside and outside, in sun and rain, in unsteady temperature conditions. The optris® MS – although lightweight and with the latest design – is rugged and easy to handle. No matter whether you carry it in your shirt pocket, at the belt or you put it into the toolbox, it should always be with you for fast inspections..

Within only 0.3 seconds you can take temperatures from  $-32$  to  $530$  °C with an accuracy of  $\pm 1$  and  $\pm 1$  °C. The installed laser helps you to aim at the measuring object, with only one click the temperature is shown on the display with a resolution of  $0.1$  °C. An alarm signal for maximum and minimum values supports a systematic scanning of the

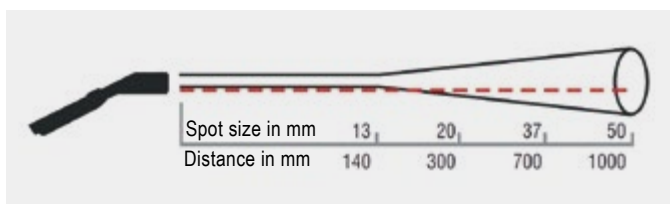

Distance-to-spot-ratio (D:S) 20:1

measuring object and a quick detection of the hot spot. The new precision optics allow to measure very small objects. If you can approach the measuring object up to 14 cm, you will have a spot size of only 13 mm. The spot size increases with growing distance. At a distance (D) of 1 meter you can take the temperature of a surface 50 mm in size (S) – consequently, the optical resolution D:S is 20:1.

### 1. Typical Applications in Maintenance and Service

Defective switchgears, fuses, engines and electrical connections are barely visible with the naked eye. But it is common knowledge, that most production facilities, which consume electricity or transfer mechanical power, heat up in case of a malfunction.

Non-contact temperature measurement is an important instrument in preventive maintenance in order to guarantee the safeness of facilities.

The optris® LS portable thermometers offer a spot size of 1 mm, only. Combined with the laser sighting technique they are the ideal tools for fast everyday temperature measurements of a vast number of measuring objects in a company.

- Temperature measurements of moving machines and facilities, electrical connections of engines and of objects in hazardous surroundings
- Detection of loose connection joints
- Localization of hidden failures in cable channels
- Inspection of fuses and circuit breakers
- Monitoring the low and medium voltage facilities
- Detection of one-sided overload and unbalanced energy distribution
- Checking transformers and small components



Portable Optris infrared thermometers

# Infrared Thermometers and Applications

## Temperature Measurement of Contacts

During the transfer of high electrical performance bus contacts often show unbalanced load distribution and overheating, which might be a safety risk. Mechanical movement of material may result in loose contacts, which – due to cyclic heating and cooling - increase their electrical resistance, which leads to a higher power consumption and generates more heat.



*Detailed infrared temperature measurement of an electric control with the help of the installed close focus optics for 1 mm ranges of the optris® LS*

Also dust and corrosion may be reasons for higher resistance. The temperature difference compared to the evenly charged contacts as well as the ambient temperature lead to conclusions on the operating condition. 10 K difference indicate a bad connection, 30 K imply a critical state.

## Checking the Transformers

Transformers have a maximum operating temperature. Unduly heating of wirings of the air transformer indicates a malfunction. A reason for that can either be the wiring or an unsteady charging of the phases..

## Localization of Defective Cables

“Hidden” defects in cables may be localized by a fast scanning with infrared thermometers. Increased temperatures signalize an increased power consumption. At these points the cables can be checked for splits, corrosion and aging.

## 2. Typical Applications in Heating, Ventilation and Air Conditioning Systems

Drafty rooms or bad climate are often the result of defective or unsteady working heating, ventilation and air conditioning systems. The HVAC engineer is asked to locate the source of trouble in the shortest possible time and to prevent unscheduled shutoffs. This has been a very time-consuming and trouble-some work depending on the method. Often the engineer had to drill holes into channels in order to trace leakages in channels, jammed filters or iced refrigerating coils. The then inserted thermometers took some time to stabilise and to correctly take the air temperature of the conduit.

The use of infrared thermometers makes this work considerably easier and saves valuable working time. Surface temperatures of components can now be taken from a safe dis-



*Überprüfen der Temperatur an Heizkreisen*

tance in a fast and comfortable way. There is no more need for ladders. HVAC engineers need measuring tools, which work efficiently and reliably, which have a rugged design and are easy to handle.

### The optris® LS LT supports:

- to detect defective isolations
- to find leakages in floor heating systems
- to check burners of oil heaters and gas boilers
- to control heat exchangers, heating circles as well as heating distributors
- to locate leakages in conduits
- to control air outlets and safety valves
- to regulate thermostats or to condition the air of a room

### Controlling the Air Conduits

Air conduit joints are often sources of trouble. They either loosen because of vibrations or because of the constant expansion and contraction of the conduits when cold and warm air runs through. Cracks may lead to a overloaded climate aggregate and may shorten their durability. Regular controls

of the conduits with infrared thermometers support to detect and monitor unbalanced temperature distribution (increase or drop of temperatures) which may lead to leakages, cracks or indicate defective isolation.

#### Checking the Outlets for Supply Air and Extracted Air

Differences in temperatures between supply and extracted air indicate malfunctions. 10 to 12 K are normal in cooling processes. If values rise above 12 K too few air might be running and the cooling liquid might be too cold. If values drop below 10 K they indicate jammed refrigerating coils, where the cooling liquid cannot pass. Temperatures in heating systems may vary between 15 and 40 K. If temperatures show more variation, jammed filters or malfunction in heat exchangers may be the reason.

#### Regulating the Condition of the Air of a Room

The engineer needs detailed information on the temperature distribution inside a room in order to dimension climate aggregates or evaluate air outlets. With an optris infrared thermometer walls, ceilings and floors can be scanned in seconds. Just aim at the measuring surface and the temperature is displayed. With the help of the measuring data the HVAC engineer is able to create the optimal climate. Thus, optimal ambient conditions help to protect devices and facilities and furthermore build a healthy climate for the employees.

#### Checking Burners

Infrared temperature measurement helps to check burners of oil heating systems and gas boilers. The results offer information on the sources of trouble. Increased temperatures imply jammed heat exchangers and polluted surfaces on the side of the flame.

### 3. Typical Applications of Car Analysis

The important factor is to locate and mend sources of trouble as quickly as possible. Please find here some examples of how to use non-contact temperature measurement in order to prevent repetitive exchange of expensive components: Analysis of:

- malfunction in engines,
- overheating of catalytic converters,
- engine management system,
- air conditioning system,
- cooling system or
- braking system.

#### Checking the Functionality of Brakes and Tyres

In order to check the reason for an unsteady braking behavior, drive the car straight ahead and brake. Instantly take the temperature of the brake drums and disks. Big temperature differences indicate jammed brake calipers and brake pistons, which have functioning problems.

#### Controlling the Heating

Check the temperature of the cooling liquid at the upper end of the pipe when the engine is warm. If the temperature drops notably below 95 °C the thermostat might not close. Afterwards take the temperatures of input and output of the pipes of the splattering wall. A 20 K increase in temperatures at the supply is normal. A cold outlet pipe implies that no cooling liquid runs through the heating system. Either the heat exchanger is jammed or the heating control spool is closed.

#### Analysis of the Cooling System

The engine runs warm, but you cannot find a leakage in the cooling system. Causes for that could be various: a jammed radiator block, a defective fan sensor, a defective thermostat or a worn out rotor in the coolant pump.

You already checked the cooler, cooling liquid sensor and catalytic converter. The thermostat needs to be controlled with the engine idling warm in neutral gear. Afterwards take the temperature of the upper end of the cooling pipe and of the thermostat housing.

With the engine reaching a temperature of 80 to 105 °C, the thermostat should open and you should see a temperature increase in the upper end of the cooling pipe. If the values remain unchanged, no cooling liquid is running and the thermostat can be located as source of problem.



Checking the heating system

#### Advantages of Infrared Thermometers at a glance:

- easy to handle
- work non-contact and deliver precise measurement results within seconds
- carry out safe inspections on hot components or objects in hazardous surroundings
- locate sources of problem without exchanging components
- detect weak points before they become a problem
- save valuable time and money

# Infrared Thermometers and Applications

## Online Infrared Thermometers

Online infrared temperature sensors are applicable for quality management purposes in production lines. In addition to the non-contact temperature measurement and the display of the results the user is able to control and manage the process temperatures. The wide range of possibilities to adjust infrared sensors to the measuring task allows an easy upgrade in existing production facilities as well as in the long-term planned equipment in cooperation with OEM customers in the machine construction industry.

Manifold applications are:

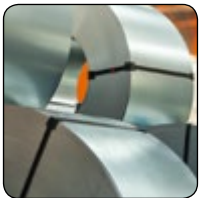

Metal industry



Plastics processing



Paper processing



Glass processing



Laser welding process

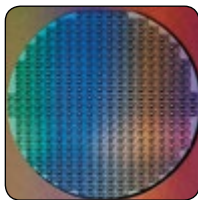

Electronic components



Automobile industry



Medicine science



Food production

### 1. Temperature measurement during induction hardening



optris® CTlaser 1M/2M/3M devices for the use at induction hardening

Heat treatment gained high importance within the metal industry. Characteristics, such as corrosion resistance, magnetism, hardness, ductility, scuff resistance and breaking behaviour can be influenced by targeted heat treatment. Induction heating is one kind of heat treatment. Work-pieces are brought into a strong electromagnetic field, therefore heated and finally frozen in a defined texture.

It is possible to locally define the depth of impression of the heat into the material by controlling the frequency. The aimed texture structure of the metal depends on the ideal temperature time process. Therefore it is important to permanently monitor the temperature.

Due to high electromagnetic fields, the optris® CTlaser 1M, 2M and 3M, are ideal for this application as the electronic is separated from the sensing head and therefore protected from the radiation.



## 2. Process Control at Thermoforming

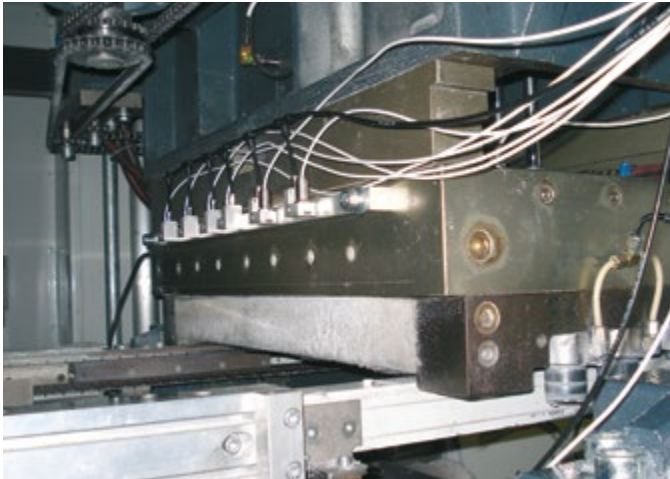

*Small optris® CT LT sensing heads installed in a machinery with a laminar air purge collar*

Plastic processors are producing a wide range of plastic products with different dimensions, thickness, textures, colors and embossing examples.

The production of products lays within multiple thermal processes. Infrared thermometers are used for temperature measurement and control, if the critical areas within the process are known.

An important operational area is the installation in thermoforming machinery. Within thermoforming processes, the base material will be heated with emitters and thermally homogenized. A correct setup of the forming temperature and its high homogeneity will lead to high quality forming processes. Infrared thermometers such as the optris® CT LT will be setup in one line at the heating zone exit to monitor the temperature profile and visualize temperature gradients.



## 3. Paper web production and glueing processes



*Infrared temperature measurement in paper and cardboard processing*

Online infrared thermometers are used to control the temperature of paper web and the application of glue during the manufacturing of corrugated paper. The high production speed of running paper web in modern laminating facilities require a precise and fast control of the paper temperature, of the glue and of the basic product, which needs to be concealed. An accurate laminating is only possible, if the necessary temperature balance for this process is taken care of at all times.

The use of miniaturized infrared temperature sensors from Optris along the paper web of the press-on roller and along the machine applying the glue in order to monitor and manage the temperatures support a steady laminating process. Air purging and cleaning processes on the optical channels of the infrared sensors support a maintenance-free measurement. The intelligent signal processing of the infrared sensors right along the track facilitate a geometrical correction of the glue application process.



# Infrared Thermometers and Applications

## 4. Temperature control of Electronic Components during Function Tests

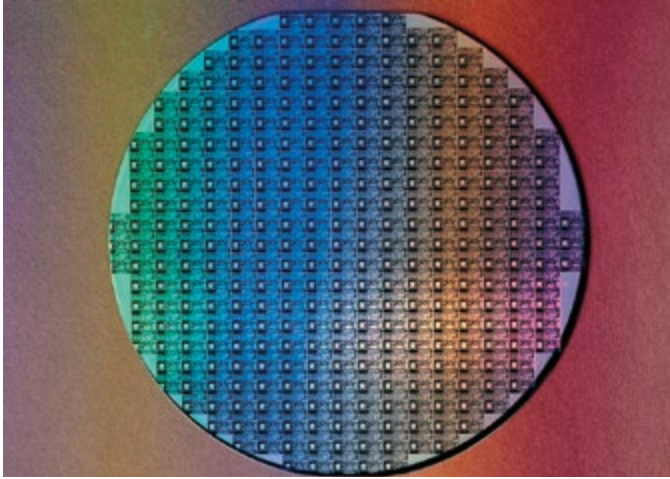

*Infrared temperature measurement of wafers and electronic components*

Increasingly more manufacturers of electronic components and PCB's use non-contact temperature measurement in order to monitor and check the thermal behavior of their products.

Infrared cameras support a detailed real-time analysis of the thermal reaction of circuit boards in research and development as well as in serial production. Under certain circumstances high production numbers and the increasing number of test and calibration stations make the use of infrared thermal cameras too expensive. The miniaturized infrared temperature sensors optris® CT LT can be applied for serial monitoring of critical components in production facilities. The result is at once communicated to the test desk for further decision making. That way smallest spot sizes of only 0,6 mm can be monitored with an optris® CT LT and an installed focus lens.

## 5. Monitoring the Product Temperature in Laser Welding and Laser Cutting Processes



*Infrared temperature measurement in laser welding processes*

To join and cut with the help of lasers appears to be a very sophisticated, cost- and time-effective technology. These processes use the precision of lasers and a high energy concentration. More accuracy on the cutting edge and shorter retention times combined with a higher temperature require a high quality product handling and compensation routine. Expansion in length according to temperature changes is one result for a deterioration in accuracy.

The miniaturized infrared temperature sensors optris® CT LT measure the product temperature at the cutting or joining edge very quickly and react with corresponding correction signals. The optris® CT LT and an installed focus lens can measure small spots of 0.6 mm. Thus production engineers have a measurement and control system, which works continuously and monitors the temperature reaction of the products in order to:

- quickly adjust and start facilities during batch changes, reducing idle times and test material
- monitor and record batch production
- guarantee a high and constant process quality





# Thermal Imagers and Applications

## What web cams and IR cameras have in common

To see local warming and therefore weak points in our environment has been fascinating all the time within modern thermal imaging technology. Based on more efficient manufacturing technologies for the IR optical image sensors, those cameras resulted in a drastic improvement of their price-performance ratio.

The devices got smaller, more robust and more economic in their power consumption. For some time now there are measuring thermographic systems available, which are – similar to a traditional web-cam – controlled and powered only by an USB port.



Thermal imager with power supply via USB of a Tablet-PC

## Introduction

IR cameras are working like normal digital cameras: They have a sighting area, the so called field of view (FOV), which can typically vary between 6° for a telescopic optic and 48° for a wide angle optic. Most standard optics are showing a 26° FOV. The farther the object is away the larger the observed area will be. But also the part of the image is increasing which is representing a single pixel. The good thing about it is that the radiation density is independent from the distance considering sufficient large measuring areas. Therefore, to a wide extend temperature measurements are not influenced by the distance to a measuring object. [1]

In the range of middle infrared the heat radiation can only be focused with optics made of germanium, germanium alloys,

zinc salts or with surface mirrors. Those coated optics are still representing a significant cost factor in thermal imagers compared to the usual, in big volume manufactured optics for the visible light. They are designed as spherical three lens or as aspheric two lens arrangements. Especially for cameras with exchangeable optics each optic has to be calibrated for each single pixel in order to get correct measurements.

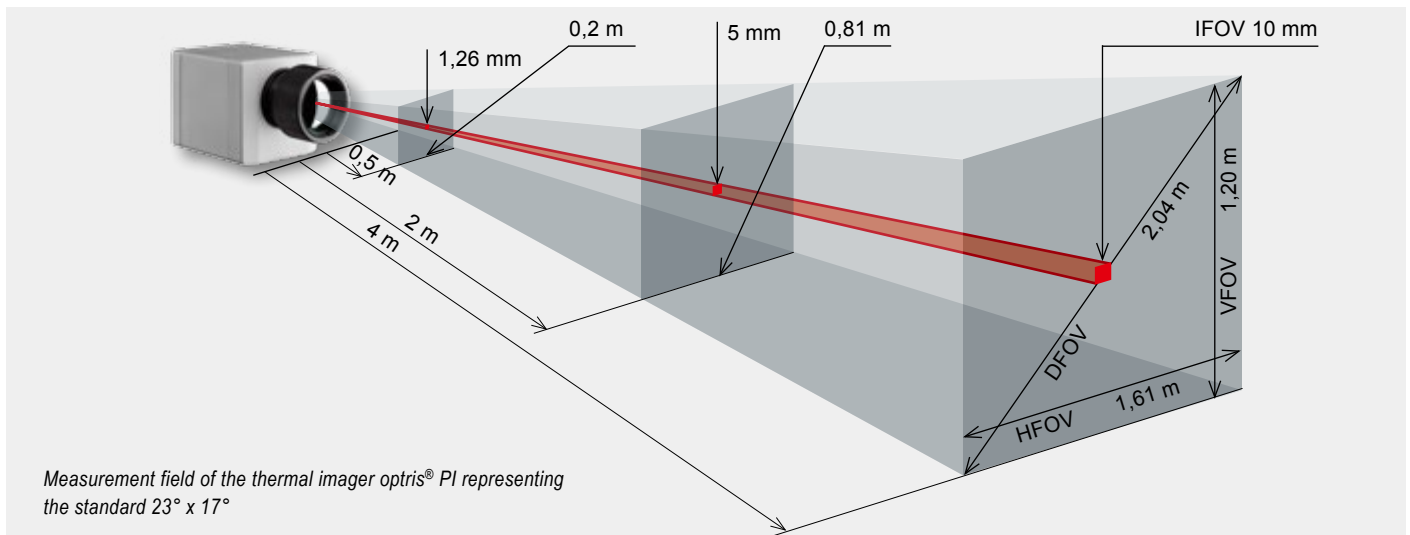

Measurement field of the thermal imager optris® PI representing the standard 23° x 17°

Exact measurement field sizes can be determined with our optics calculator: <http://www.optris.com/optics-calculator>

# Thermal Imagers and Applications

In almost all worldwide used thermographic systems the heart of those cameras is a focal plane array (FPA), an integrated image sensor with sizes of 20.000 to 1 million pixel. Each pixel itself is a  $17 \times 17 \mu\text{m}^2$  to  $35 \times 35 \mu\text{m}^2$  big micro bolometer. Those 150 mm thick thermal detectors are heated up by the heat radiation within 10 ms to about a fifth of the temperature difference between object and chip temperature. This extremely high sensitivity is achieved by a very low thermal capacity in connection with a superb insulation to the silicon circuit and to the evacuated environment. The absorption of the semitransparent receiver area is improved by the interference of the transmitted and on the surface of the read out circuit reflected light wave with the succeeding light wave. [3]

To use this effect of self interference the bolometer area has to be positioned in about  $2 \mu\text{m}$  distance from the read out circuit. Special etching techniques have to be used to structure the applied vanadium oxide or amorphous silicon materials. The specific detectivity of the described FPA's is achieving values of  $10^9 \text{ cm Hz}^{1/2}/\text{W}$ . It is therefore one magnitude better than other thermal detectors which are for example used in pyrometers.

With the bolometer's intrinsic temperature its resistance is changing. This change generates an electrical voltagesignal. Fast 14 bit A/D converters are digitizing the amplified and serialized video signal. A digital signal processing is calculating a temperature value for each pixel. In real time it generates the known false color images.

Thermal imaging cameras are requiring a relative extensive calibration in which a number of sensitivity values are allocated to each pixel at different chip and black body tempera-

tures. To increase the measuring accuracy bolometer FPA's are often stabilized at defined chip temperatures with high control accuracy.

Due to the development of better performing, smaller and at the same time less expensive laptops, UMPCs, netbooks and tablet PCs it is nowadays possible to use their

- big displays for attractive thermal image presentations,
- optimized Li-Ion rechargeable batteries as power supply,
- computation capacity for a flexible and high value real time signal display,
- large memories for practically unlimited infrared video records and
- Ethernet, Bluetooth, WLAN and Software interfaces for the integration of the thermographic system into their application environment.

The standardized and everywhere available USB 2.0 interface assures data transmission rates of

- 30 Hz with  $320 \times 340$  pixel image resolution and
- 120 Hz with image sizes of 20.000 pixel.

The 2009 introduced USB 3.0 technology is even suitable for XGA thermal image resolutions up to 100 Hz video frequency. In the area of thermography the use of the webcam principle enables totally new product features with a significant improved price performance ratio. The infrared camera is connected via a 480 MegaBaud interface in real time with a Windows® based computer which at the same time is supplying the required power.



*USB infrared cameras with a resolution up to  $640 \times 480$  pixel and up to 1.000 Hz*

## The hardware of USB IR cameras

In the past USB has been seen as a pure office communication medium. But opposite to FireWire, very broad use has initiated a number of developments to improve the industrial applicability and therefore the usability for a number of USB 2.0 end devices – especially of USB cameras. Those new product developments are:

- rugged up to 200 °C usable USB cables with lengths of up to 10 m, applicable also in cable carriers [4]
- Cat. 5e (Ethernet) 100 m long cable extensions with signal amplifiers
- Optical fibre to USB modems for fibre cable lengths of up to 10 km [5]

Based on the high bandwidth of the USB bus up to six 120 Hz IR cameras can be connected via a standard hub over a 100 m Ethernet cable to a laptop.

The water tight, vibration and shock resistant thermal imaging devices are NEMA 4 rated and therefore also suitable for demanding applications in test booths. The size of 4 x 5 x 4 cubic centimeters and the weight of 200 grams are reducing the effort for cooling housings and air purges significantly.

Due to the thermal drift of bolometer's and their on chip signal processing all worldwide marketed measuring IR cameras need an offset correction every few minutes. This correction is done by a motor driven motion of a blackened metal piece in the front of the image sensor.

In this way each image element is referenced with the same temperature. During those offset calibrations thermal cameras are of course blind. In order of minimizing this disturbing effect the offset correction can be initiated by an external control pin at a suitable point of time. At the same time the cameras are designed to minimize the duration of their self

calibration: Within the here discussed USB IR camera the use of corresponding fast actors allows a self referencing within 250 ms. This is comparable with the duration of an eye lid motion and therefore acceptable for a lot of measurement processes. In conveyor belt processes in which sudden hot spots have to be detected timely generated "good" reference images can often be used as dynamic difference images. In this way a continuous mode is possible without a mechanically moved component.



*For offset compensation the whole field of view of an infrared sensor array is closed by a linear motor for a short time*

Especially in applications where 10.6 µm-CO<sub>2</sub>-lasers are used an externally controlled closure of the optical channel is favorable in connection with an independent signalization of this self protected mode. Based on a good filter blocking all other typically in the spectral range between 800 nm and 2.6 µm working lasers are allowing temperature measurements during their operation.

### Main application areas of the described thermal imaging device are:

- the analysis of dynamic thermal processes during the product and process development,
- the stationary use for a continuous monitoring and control of heating and cooling procedures and
- the occasional use in the electrical and mechanical maintenance and for the detection of heat leakages in buildings.



# Thermal Imagers and Applications

For the application in the R&D area the possibility of a 120 Hz video recording is very advantageous. Thermal processes only shown in the camera's field of view for a short time can be analyzed in slow motion. Afterwards single images can be generated in full geometric and thermal resolution out of such a video sequence. In addition, exchangeable optics including a microscope accessory are offering a lot of possibilities to adapt the camera to different measuring tasks. While 9° optics are rather suitable to monitor details from a greater distance, a microscope accessory can be used to measure objects of 5,5 x 4,2 mm<sup>2</sup> size with a geometric resolution of 35 x 35 μm<sup>2</sup>.

For the online use of USB IR cameras an optically isolated process interface is advantageous. Out of the thermal image generated temperature information can be supplied as voltage signal. In addition, area referenced emissivities and contact or noncontact measured reference temperatures can be transmitted via a voltage input to the camera system. For documentation purposes an additional digital input can initialize snapshots and video sequences. Those thermal images can be stored automatically on central servers. Documenting each single piece of a production lot temperature and especially uniformity information can be monitored from different computers within a network.

## Thermal analysis software guaranties flexibility

There is no driver installation needed because USB IR cameras are using the already in Windows XP and higher integrated standard USB video class and HID driver. The single pixel related real time correction of the video data and the temperature calculation are done on PC. A for only 20.000 sensor pixel impressive image quality is achieved by a complex software based rendering algorithm which is calculating temperature arrays in VGA format.

The application software is characterized by a high flexibility and portability. Besides functions which are standard for a thermographic software there are advanced features like:

- mixed scalable color pallets with isotherms,
- many data and thermal image export functions to support reports and offline analyses,
- horizontal and vertical line displays,
- unlimited number of measuring areas with separate alarm options,
- difference video displays based on reference images, temperature/ time diagrams for different regions of interest

Furthermore, the software offers a layout mode which saves different display adjustments. An integrated video software enables the editing of radiometric AVI files. Such files can also be analyzed offline based on the multiple in parallel usable software. The video acquisition modes are also allowing the intermittent recording of slow thermal processes and their fast display.

The transfer of real time data to other programs is done by a comprehensive documented DLL as a part of a software development kit. Via this DLL interface all other camera functions are also controllable. Alternatively the software can communicate with a serial port. Using this data link, RS422 adapters can be connected directly.

## Applications

In the next chapter three typical applications are discussed. They are representing examples out of a wide field of camera uses

### 1. Optimization of manufacturing processes

The production of plastic parts like PET bottles requires a defined heat up of the so called preforms in order to guaranty a homogeneous material thickness during the blow molding. Test runs are done with only a few of the 20 mm thick blanks with full working speed of about 1 m/s.

In order to measure the temperature profile of a preform a video sequence with 120 Hz has to be recorded because the moment can vary where those blanks are in the field of view. The camera is positioned in such a way that it follows

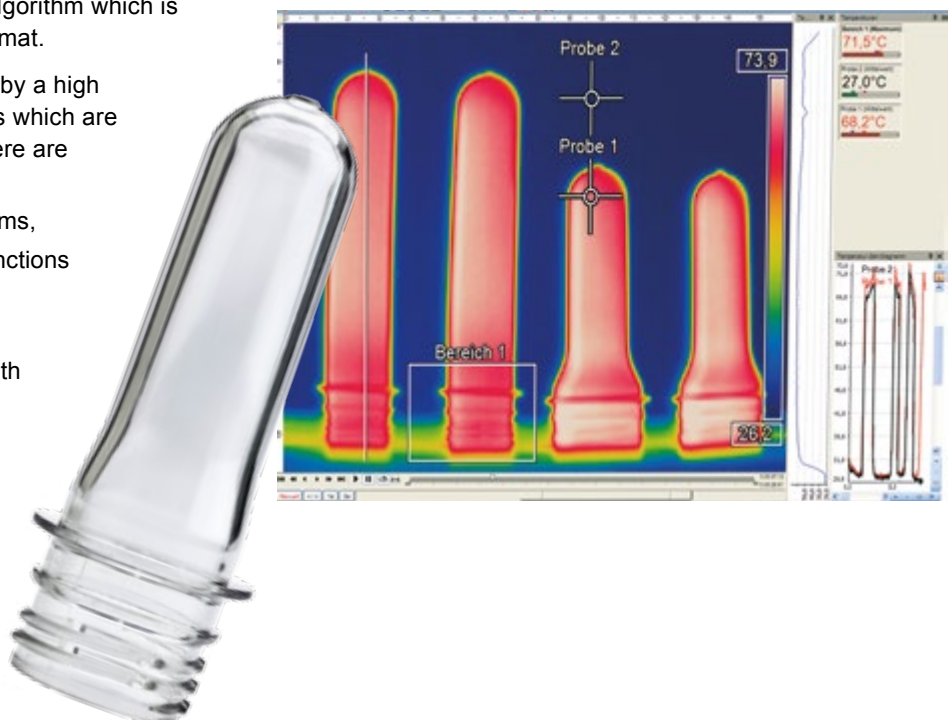

the motion of the material under an oblique angle – similar to the view to the last wagon of a running train. The IR video sequence delivers finally the right temperature profile which is important for the adjustment of all heating parameters.

During the vacuum forming of big plastic parts of refrigerators video recordings are allowing the exact determination of the cooling behavior at partial areas of form pieces. Different cooling speeds may result in a warp of the material. Also optimizing the cooling speed may avoid memory effects in the plastic. Those effects are basically representing form changes after a certain time for example on dash boards. Similar to an oscilloscope for the analyses of electric signal behaviors the IR video camera is an important tool to qualify dynamic thermal processes.

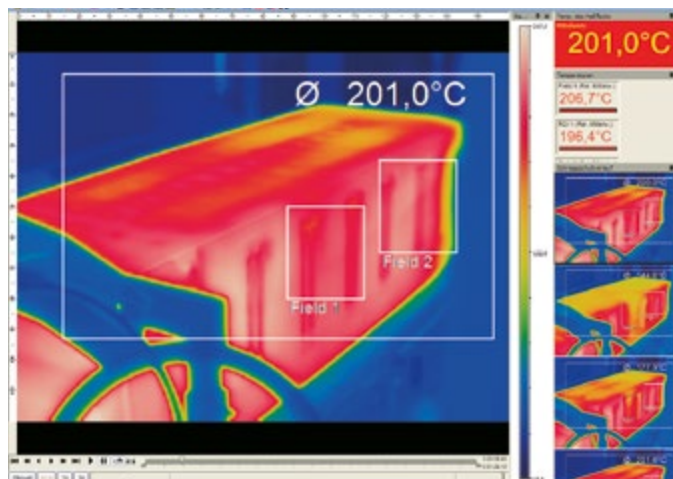

Examples for the different possibilities of the IR video and image analysis

## 2. H1N1 fever inspection of travelers



Monitoring skin surface temperature of travelers

The virus epidemic of the swine flue disease created a worldwide demand of suitable screening techniques allowing a fast non contact detection of travelers with possible fever. Base is the measurement of the face temperature in the area of the eye cavity as a measure for the body core temperature. Although this method does not represent an absolute accurate fever temperature measurement nevertheless it is suitable to screen bigger groups of travelers with sufficient high detection reliability.

Normal IR cameras are only  $\pm 2$  °C accurate due to the limited

- stability of the sensing system and the and
- imaging quality of the highly opened optics.

For measurements in the medical area this uncertainty is not sufficient enough. As a result flat small reference radiators have been developed allowing at 34 °C radiation temperature a measuring accuracy of 0.2 °C. Those radiators are positioned at the border of the IR image in the same distance of the skin surface. Core of the measurement system is a certified IR thermometer with 25 mK thermal resolution. Within the reference radiator integrated device this is measuring its heat radiation. The actual temperature values are transmitted via a 4–20 mA interface to the analogue port of the IR camera. The software is calculating in the respective image area a correction value which is also used for all other pixels of the measuring image. At the presumed fever temperature an alarm is automatically generated and a radiometric image is stored for documentation. For the affected persons a contact fever measurement has to be done for example by using an ear thermometer.

# Thermal Imagers and Applications

## 3. Line scanning in glass toughening lines

After construction glasses had been cut to their final form quite often they have to be toughened on their surface. This is done in glass toughening furnaces in which the cut glasses are heated up to about 600 °C. After the heat up movable rolls are transporting the material from the oven into a cooling section. Here the surface is cooled down quickly with the same speed. In this way a fine crystalline hardened structure is generated which is especially important for safety glasses. The fine structure and especially the braking strength of the glass depends on a uniform heating and cooling pattern for all partial areas of the glass material.

Because oven housing and cooling section are located close to each other it is only possible to monitor the oven leaving glass surfaces through a small slot. As a result in the infrared image the material is shown only in a few lines. The software displays the glass surface as an image generated out of lines or line groups. Those lines are taken out of every 8 ms recorded thermal images.

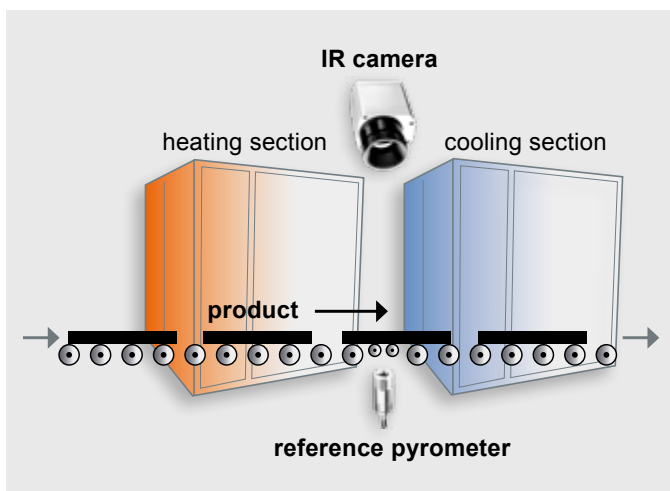

Thermal image measurement on a glass toughening line with IR camera and reference pyrometer

The camera is measuring the slot in a diagonal mode allowing, with a 48° optic, an overall field of view of 60°. Glass has different emissivities depending on its coating layers. An IR thermometer is measuring the exact temperature on the non coated lower side at the for those surfaces optimal wavelength of 5 µm. Those along a column of the measuring image generated temperatures are transmitted to the analogue input of the camera. They are compared constantly with the corresponding camera measuring values. As the result a corrected emissivity is calculated for the overall measuring image. Finally those measuring images are allowing an exact adjustment of all heating sections in the oven assuring a good thermal homogeneity.

## 4. Infrared cameras for aerial thermography

The application of thermal imaging cameras on drones and other airborne objects is growing. The scope of application is hereby quite broad: from the control and thermal analysis of major industrial facilities and buildings, follow-up fire monitoring to find smoldering nests and missing persons, and further to taking a population census in the field. Airborne operated thermography for quality assurance of photovoltaic systems is of particular significance. The systems must operate efficiently to quickly redeem the high acquisition costs. To ensure this reliable operation, faulty solar modules must be promptly repaired.

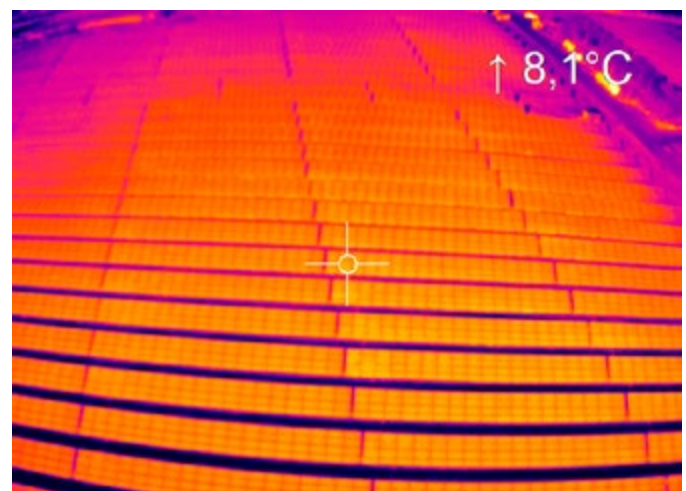

Temperature monitoring of solar farm

### 5. Inline temperature measurement technology for food production plant management

The challenge in producing ready-made meals, is to produce a finished product containing different ingredients that tastes good despite industrial preparation. Due to reasons of food safety, all ingredients are required to be heated to 95 °C. If a steam cooker was used for processing, the vegetables would turn to mush before the meat was cooked.



Temperature monitoring during heating of broccoli florets

The globally unique processing technology of the Naprotec company, located in Zetel, uses microwave technology for heating. It takes advantage of the effect that each food has its own individual frequency for particularly fast heating. In compliance with the HACCP concept (Hazard Analysis and Critical Control Points), the monitoring of the pasteurization temperatures of the ready-made meals, which are sealed in PE foil-covered tubs, and the management of the system is conducted by using an optris® PI 160 infrared camera.

### Conclusions

The new IR imaging technology represents a novelty with respect to flexibility and width of its possible applications. Besides of sophisticated temperature analysis when connected to tablet PCs the device can also be used to solve simple maintenance tasks. With the exception of the hardware of the USB IR camera measuring heads itself both significant other components of the described thermographic system – Windows software and PC hardware – can also be actualized later. This is done on the one hand side by simple downloads of software updates and extensions. And on the other hand side due to the standard USB interface the measuring system can be supplemented with technologically and functionally further developed PC hardware at any time.

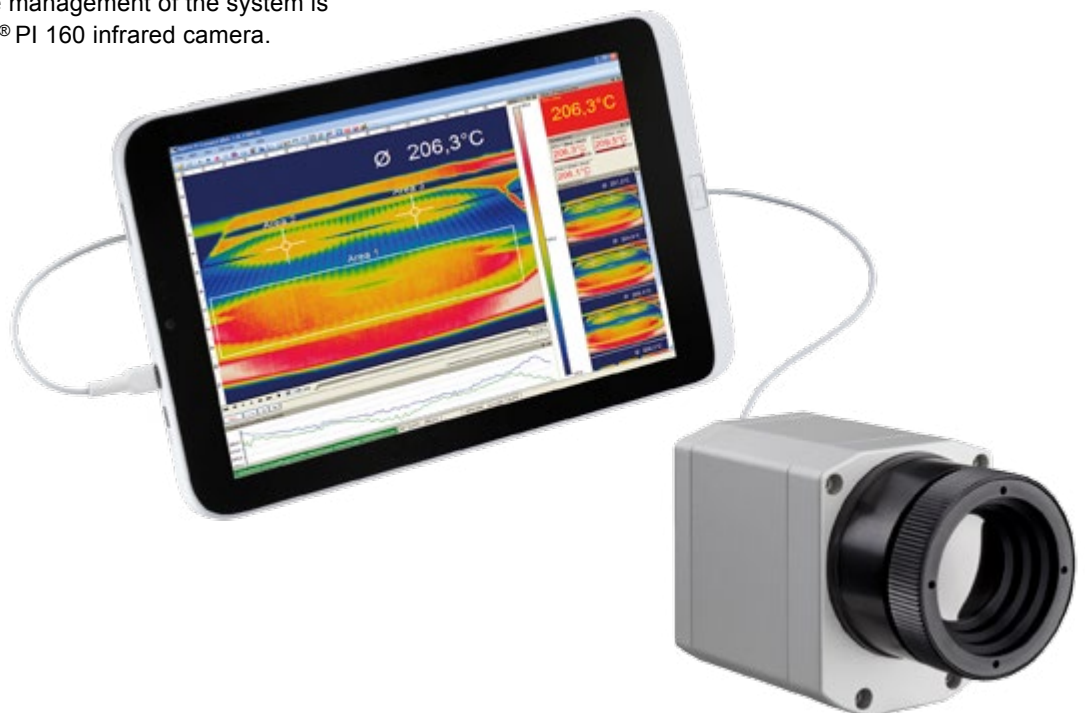

# Literature

## References

- [1] VDI/VDE Richtlinie, Technische Temperaturmessungen – Spezifikation von Strahlungsthermometern, Juni 2001, VDI 3511 Blatt 4.1
- [2] VDI/ VDE Richtlinie Technische Temperaturmessungen, Strahlungsthermometrie – Kalibrierung von Strahlungsthermometern, 2004, VDI/ VDE 3511, Blatt 4.3
- [3] Trouilleau, C. et al.: High-performance uncooled amorphous silicon TEC less XGA IRFPA with 17  $\mu\text{m}$  pixel-pitch; "Infrared technologies and applications XXXV", Proc. SPIE 7298, 2009
- [4] Schmidgall, T.; Glänzend gelöst – Fehlerdetektion an spiegelnden Oberflächen mit USB2.0 – Industriekameras, A&D Kompendium 2007/2008, S. 219
- [5] Icron Technology Corp.; Options for Extending USB, White Paper, Burnaby; Canada, 2009

## Recommended Literature

1. VDI/VDE Richtlinie, Technische Temperaturmessungen – Spezifikation von Strahlungsthermometern, Juni 2001, VDI 3511 Blatt 4.1
2. Stahl, Miosga: Grundlagen Infrarottechnik, 1980, Dr. Alfred Hütthig Verlag Heidelberg
3. Walther, Herrmann: Wissensspeicher Infrarotmesstechnik, 1990, Fachbuchverlag Leipzig
4. Walther, L., Gerber, D.: Infrarotmesstechnik, 1983, Verlag Technik Berlin
5. De Witt, Nutter: Theory and Practice of Radiation Thermometry, 1988, John Wiley & Son, New York, ISBN 0-471-61018-6
6. Wolfe, Zissis: The Infrared Handbook, 1978, Office of Naval Research, Department of the Navy, Washington DC.
7. Crastes, A. et al.: Uncooled amorphous silicon  $\frac{1}{4}$  VGA IRFPA with 25  $\mu\text{m}$  pixel-pitch for High End applications, "Infrared technologies and applications XXXIV", Proc. SPIE 6940, 2008
8. Holst, Gerald C.: Electro-optical Imaging System Performance, JCD Publishing Winter Park, Florida USA, 2006, ISBN: 0-8194-6179-2
9. Ulrich Kienitz: Thermal imaging as a modern form of pyrometry, in: Journal of Sensors and Sensor Systems, 3, 265–271, 2014.



Term	Explanation
Absorption	Ratio of absorbed radiation by an object to incoming radiation. A number between 0 and 1.
Emissivity	Emitted radiation of an object compared to the radiation from a black body source. A number between 0 and 1.
Filter	Material, permeable for certain infrared wavelengths only.
FOV	Field of view: Horizontal field of view of an infrared lens.
FPA	Focal Plane Array: type of an infrared detector.
Grey Body Source	An object, which emits a certain part of the energy which a black body source emits at every wavelength.
IFOV	Instantaneous field of view: A value for the geometric resolution of a thermal imager.
NETD	Noise equivalent temperature difference. A value for the noise (in the image) of a thermal imager.
Object parameter	Values, with which measurement conditions and measuring object are described (e.g. emissivity, ambient temperature, distance a.s.o.)
Object signal	A noncalibrated value, which refers to the radiation the thermal imager receives from the measuring object.
Palette	Colors of the infrared image
Pixel	Synonym for picture element. A single picture point in an image.
Reference temperature	Temperature value to compare regular measuring data with.
Reflection	Ratio of radiation reflected by the object and incoming radiation. A number between 0 and 1.
Black body source	Object with a reflection of 0. Any radiation is to be traced back to its temperature.
Spectral specific radiation	Energy emitted by an object related to time, area and wavelength ( $W/m^2/\mu m$ ).
Specific radiation	Energy emitted from an object related to units of time and area ( $W/m^2$ ).
Radiation	Energy emitted by an object related to time, area and solid angle ( $W/m^2/sr$ ).
Radiation flow	Energy emitted by an object related to the unit of time (W).
Temperature difference	A value, which is determined by subtraction of two temperature values.
Temperature range	Current temperature measuring range of a thermal imager. Imagers can have several temperature ranges. They are described with the help of two black body source values, which serve as threshold values for the current calibration.
Thermogram	Infrared image
Transmissivity	Gases and solid states have different transmissivities. Transmissivity describes the level of infrared radiation, which permeates the object. A number between 0 and 1.
Ambient surroundings	Objects and gases, which pass radiation to the measuring object.

# Appendix: Emissivity Table

In the following you will find a list of emissivities from technical literature and from measurements carried out by the Optris GmbH.

## References

1. Mikaél A. Bramson: Infrared Radiation, A Handbook for Applications, Plenum Press, N.Y.
2. William L. Wolfe, George J. Zissis: The Infrared Handbook, Office of Naval Research, Department of Navy, Washington, D.C.
3. Madding, R.P.: Thermographic Instruments and Systems. Madison, Wisconsin: University of Wisconsin – Extension, Department of Engineering and Applied Science
4. William L. Wolfe: Handbook of Military Infrared Technology, Office of Naval Research, Department of Navy, Washington, D.C.
5. Jones, Smith, Probert: External thermography of buildings ..., Proc. Of the Society of Phot-Optical Instrumentation Engineers, vol. 110, Industrial and Civil Applications of Infrared Technology, Juni 1977 London
6. Paljak, Pettersson: Thermography of Buildings, Swedish Building Research Institute, Stockholm 1972
7. Vlcek, J.: Determination of emissivity with imaging radiometers and some emissivities at  $\lambda = 5 \mu\text{m}$ . Photogrammetric Engineering and Remote Sensing.
8. Kern: Evaluation of infrared emission of clouds and ground as measured by weather satellites, Defence Documentation Center, AD 617 417.
9. Öhman, Claes: Emittansmätningar med AGEMA E-Box. Teknisk rapport, AGEMA 1999. (Emissionsmessungen mit AGEMA E-Box. Technischer Bericht, AGEMA 1999.)

T: total spectrum SW: 2–5 μm LW: 8–14 μm LLW: 6,5–20 μm					
					References
Material	Specification	Temperature in °C	Spectrum	Emissivity	R
Aluminum	Plate, 4 samples differently scratched	70	LW	0.03–0.06	9
Aluminum	Plate, 4 samples differently scratched	70	SW	0.05–0.08	9
Aluminum	anodized, light grey, dull	70	LW	0.97	9
Aluminum	anodized, light grey, dull	70	WS	0.61	9
Aluminum	anodized, light grey, dull	70	LW	0.95	9
Aluminum	anodized, light grey, dull	70	SW	0.67	9
Aluminum	anodized plate	100	T	0.55	2
Aluminum	film	27	3 μm	0.09	3
Aluminum	film	27	10 μm	0.04	3
Aluminum	harshened	27	3 μm	0.28	3
Aluminum	harshened	27	10 μm	0.18	3
Aluminum	cast, sandblasted	70	LW	0.46	9
Aluminum	cast, sandblasted	70	SW	0.47	9
Aluminum	dipped in HNO <sub>3</sub> , plate	100	T	0.05	4
Aluminum	polished	50–100	T	0.04–0.06	1
Aluminum	polished, plate	100	T	0.05	2
Aluminum	polished, plate	100	T	0.05	4
Aluminum	harshened surface	20–50	T	0.06–0.07	1
Aluminum	deeply oxidized	50–500	T	0.2–0.3	1
Aluminum	deeply weather beaten	17	SW	0.83–0.94	5
Aluminum	unchanged, plate	100	T	0.09	2
Aluminum	unchanged, plate	100	T	0.09	4
Aluminum	vacuumcoated	20	T	0.04	2
Aluminum bronze		20	T	0.6	1
Aluminumhydroxid	powder		T	0.28	1
Aluminumoxid	activated, powder		T	0.46	1
Aluminumoxid	clean, powder (aluminiumoxide)		T	0.16	1
Asbestos	floor tiles	35	SW	0.94	7
Asbestos	boards	20	T	0.96	1
Asbestos	tissue		T	0.78	1
Asbestos	paper	40–400	T	0.93–0.95	1
Asbestos	powder		T	0.40–0.60	1
Asbestos	brick	20	T	0.96	1
Asphalt, road surface		4	LLW	0.967	8
Brass	treated with 80-sandpaper	20	T	0.2	2
Brass	plate, milled	20	T	0.06	1
Brass	plate, treated with sandpaper	20	T	0.2	1
Brass	strongly polished	100	T	0.03	2
Brass	oxidized	70	SW	0.04–0.09	9
Brass	oxidized	70	LW	0.03–0.07	9

Material	Specification	Temperature in °C	Spectrum	Emissivity	R
Brass	oxidized	100	T	0.61	2
Brass	oxidized at 600 °C	200–600	T	0.59–0.61	1
Brass	polished	200	T	0.03	1
Brass	blunt, patchy	20–350	T	0.22	1
Brick	aluminiumoxide	17	SW	0.68	5
Brick	dinas-siliziumoxide, fireproof	1000	T	0.66	1
Brick	dinas-siliziumoxide, glazed, harshened	1100	T	0.85	1
Brick	dinas-siliziumoxide, glazed, harshened	1000	T	0.8	1
Brick	fireproof product, corundom	1000	T	0.46	1
Brick	fireproof product, magnesit	1000–1300	T	0.38	1
Brick	fireproof product, mildly beaming	500–1000	T	0.76–0.80	1
Brick	fireproof product, strongly beaming	500–1000	T	0.8–0.9	1
Brick	fire brick	17	SW	0.68	5
Brick	glazed	17	SW	0.94	5
Brick	brickwork	35	SW	0.94	7
Brick	prickwork, plastered	20	T	0.94	1
Brick	normal	17	SW	0.86–0.81	5
Brick	red, normal	20	T	0.93	2
Brick	red, raw	20	T	0.88–0.93	1
Brick	chamotte	20	T	0.85	1
Brick	chamotte	1000	T	0.75	1
Brick	chamotte	1200	T	0.59	1
Brick	amorphus silicon, 95 % SiO <sub>2</sub>	1230	T	0.66	1
Brick	sillimanit, 33 % SiO <sub>2</sub> , 64 % Al <sub>2</sub> O <sub>3</sub>	1500	T	0.29	1
Brick	waterproof	d17	SW	0.87	5
Bronze	phosphorbronze	70	LW	0.06	9
Bronze	phosphorbronze	70	SW	0.08	1
Bronze	polished	50	T	0.1	1
Bronze	porous, harshened	50–100	T	0.55	1
Bronze	powder		T	0.76–0.80	1
Carbon	Grafit, surface filed	20	T	0.98	2
Carbon	plumbago powder		T	0.97	1
Carbon	charcoal powder		T	0.96	1
Carbon	candle soot	20	T	0.95	2
Carbon	lamp soot	20–400	T	0.95–0.97	1
Cast Iron	treated	800–1000	T	0.60–0.70	1
Cast Iron	fluent	1300	T	0.28	1
Cast Iron	cast	50	T	0.81	1
Cast Iron	blocks made of cast iron	1000	T	0.95	1
Cast Iron	oxidized	38	T	0.63	4
Cast Iron	oxidized	100	T	0.64	2
Cast Iron	oxidized	260	T	0.66	4
Cast Iron	oxidized	538	T	0.76	4
Cast Iron	oxidized at 600 °C	200–600	T	0.64–0.78	1
Cast Iron	polished	38	T	0.21	4

# Appendix: Emissivity Table

Material	Specification	Temperature in °C	Spectrum	Emissivity	R
Cast Iron	polished	40	T	0.21	2
Cast Iron	polished	200	T	0.21	1
Cast Iron	untreated	900–1100	T	0.87–0.95	1
Chipboard	untreated	20	SW	0.9	6
Chrome	polished	50	T	0.1	1
Chrome	polished	500–1000	T	0.28–0.38	1
Clay	burnt	70	T	0.91	1
Cloth	black	20	T	0.98	1
Concrete		20	T	0.92	2
Concrete	pavement	5	LLW	0.974	8
Concrete	harshened	17	SW	0.97	5
Concrete	dry	36	SW	0.95	7
Copper	electrolytic, brightly polished	80	T	0.018	1
Copper	electrolytic, polished	–34	T	0.006	4
Copper	scraped	27	T	0.07	4
Copper	molten	1100–1300	T	0.13–0.15	1
Copper	commercial, shiny	20	T	0.07	1
Copper	oxidized	50	T	0.6–0.7	1
Copper	oxidized, dark	27	T	0.78	4
Copper	oxidized, deeply	20	T	0.78	2
Copper	oxidized, black		T	0.88	1
Copper	polished	50–100	T	0.02	1
Copper	polished	100	T	0.03	2
Copper	polished, commercial	27	T	0.03	4
Copper	polished, mechanical	22	T	0.015	4
Copper	clean, thoroughly prepared surface	22	T	0.008	4
Copperoxide	powder		T	0.84	1
Copperoxide	red, powder		T	0.7	1
Earth	saturated with water	20	T	0.95	2
Earth	dry	20	T	0.92	2
Enamel		20	T	0.9	1
Enamel	paint	20	T	0.85–0.95	1
Fiberboard	hard, untreated	20	SW	0.85	6
Fiberboard	Ottrelith	70	LW	0.88	9
Fiberboard	Ottrelith	70	SW	0.75	9
Fiberboard	particle plate	70	LW	0.89	9
Fiberboard	particle plate	70	SW	0.77	9
Fiberboard	porous, untreated	20	SW	0.85	6
Glazing Rebates	8 different colors and qualities	70	LW	0.92–0.94	9
Glazing Rebates	9 different colors and qualities	70	SW	0.88–0.96	9
Glazing Rebates	aluminium, different age	50–100	T	0.27–0.67	1
Glazing Rebates	on oily basis, average of 16 colors	100	T	0.94	2
Glazing Rebates	chrome green		T	0.65–0.70	1
Glazing Rebates	cadmium yellow		T	0.28–0.33	1
Glazing Rebates	cobalt blue		T	0.7–0.8	1

Material	Specification	Temperature in °C	Spectrum	Emissivity	R
Glazing Rebates	plastics, black	20	SW	0.95	6
Glazing Rebates	plastics, white	20	SW	0.84	6
Glazing Rebates	oil	17	SW	0.87	5
Glazing Rebates	oil, different colors	100	T	0.92–0.96	1
Glazing Rebates	oil, shiny grey	20	SW	0.96	6
Glazing Rebates	oil, grey, dull	20	SW	0.97	6
Glazing Rebates	oil, black, dull	20	SW	0.94	6
Glazing Rebates	oil, black, shiny	20	SW	0.92	6
Gold	brightly polished	200–600	T	0.02–0.03	1
Gold	strongly polished	100	T	0.02	2
Gold	polished	130	T	0.018	1
Granite	polished	20	LLW	0.849	8
Granite	harshened	21	LLW	0.879	8
Granite	harshened, 4 different samples	70	LW	0.77–0.87	9
Granite	harshened, 4 different samples	70	SW	0.95–0.97	9
Gypsum		20	T	0.8–0.9	1
Gypsum, applied		17	SW	0.86	5
Gypsum, applied	gypsum plate, untreated	20	SW	0.9	6
Gypsum, applied	harshened surface	20	T	0.91	2
Iron and Steel	electrolytic	22	T	0.05	4
Iron and Steel	electrolytic	100	T	0.05	4
Iron and Steel	electrolytic	260	T	0.07	4
Iron and Steel	electrolytic, brightly polished	175–225	T	0.05–0.06	1
Iron and Steel	freshly milled	20	T	0.24	1
Iron and Steel	freshly processed with sandpaper	20	T	0.24	1
Iron and Steel	smoothed plate	950–1100	T	0.55–0.61	1
Iron and Steel	forged, brightly polished	40–250	T	0.28	1
Iron and Steel	milled plate	50	T	0.56	1
Iron and Steel	shiny, etched	150	T	0.16	1
Iron and Steel	shiny oxide layer, plate	20	T	0.82	1
Iron and Steel	hotly milled	20	T	0.77	1
Iron and Steel	hotly milled	130	T	0.6	1
Iron and Steel	coldly milled	70	LW	0.09	9
Iron and Steel	coldly milled	70	SW	0.2	9
Iron and Steel	covered with red dust	20	T	0.61–0.85	1
Iron and Steel	oxidized	100	T	0.74	1
Iron and Steel	oxidized	100	T	0.74	4
Iron and Steel	oxidized	125–525	T	0.78–0.82	1
Iron and Steel	oxidized	200	T	0.79	2
Iron and Steel	oxidized	200–600	T	0.8	1
Iron and Steel	oxidized	1227	T	0.89	4
Iron and Steel	polished	100	T	0.07	2

Material	Specification	Temperature in °C	Spectrum	Emissivity	R
Iron and Steel	polished	400–1000	T	0.14–0.38	1
Iron and Steel	polished plate	750–1050	T	0.52–0.56	1
Iron and Steel	harshened, even surface	50	T	0.95–0.98	1
Iron and Steel	rusty, red	20	T	0.69	1
Iron and Steel	rusty, red, plate	22	T	0.69	4
Iron and Steel	deeply oxidized	50	T	0.88	1
Iron and Steel	deeply oxidized	500	T	0.98	1
Iron and Steel	deeply rusted	17	SW	0.96	5
Iron and Steel	deeply rusted plate	20	T	0.69	2
Iron tinned	plate	24	T	0.064	4
Ice:	see water				
Iron, galvanized	plate	92	T	0.07	4
Iron, galvanized	plate, oxidized	20	T	0.28	1
Iron, galvanized	plate, oxidized	30	T	0.23	1
Iron, galvanized	deeply oxidized	70	LW	0.85	9
Iron, galvanized	deeply oxidized	70	SW	0.64	9
Leather	tanned fur		T	0.75–0.80	1
Limestone			T	0.3–0.4	1
Magnesium		22	T	0.07	4
Magnesium		260	T	0.13	4
Magnesium		538	T	0.18	4
Magnesium	polished	20	T	0.07	2
Magnesium-powder			T	0.86	1
Molybdenum		600–1000	T	0.08–0.13	1
Molybdenum		1500–2200	T	0.19–0.26	1
Molybdenum	twine	700–2500	T	0.1–0.3	1
Mortar		17	SW	0.87	5
Mortar	dry	36	SW	0.94	7
Nickel	wire	200–1000	T	0.1–0.2	1
Nickel	electrolytic	22	T	0.04	4
Nickel	electrolytic	38	T	0.06	4
Nickel	electrolytic	260	T	0.07	4
Nickel	electrolytic	538	T	0.1	4
Nickel	galvanized, polished	20	T	0.05	2
Nickel	galvanized on iron, not polished	20	T	0.11-0.40	1
Nickel	galvanized on iron, not polished	22	T	0.11	4
Nickel	galvanized on iron, not polished	22	T	0.045	4
Nickel	lightly dull	122	T	0.041	4
Nickel	oxidized	200	T	0.37	2
Nickel	oxidized	227	T	0.37	4
Nickel	oxidized	1227	T	0.85	4
Nickel	oxidized at 600 °C	200–600	T	0.37–0.48	1
Nickel	polished	122	T	0.045	4
Nickel	clean, polished	100	T	0.045	1

Material	Specification	Temperature in °C	Spectrum	Emissivity	R
Nickel	clean, polished	200–400	T	0.07–0.09	1
Nickelchrome	wire, bare	50	T	0.65	1
Nickelchrome	wire, bare	500–1000	T	0.71–0.79	1
Nickelchrome	wire, oxidized	50–500	T	0.95–0.98	1
Nickelchrome	milled	700	T	0.25	1
Nickelchrome	sandblasted	700	T	0.7	1
Nickeloxide		500–650	T	0.52–0.59	1
Nickeloxide		1000–1250	T	0.75–0.86	1
Oil, Lubricating Oil	0.025-mm-layer	20	T	0.27	2
Oil, Lubricating Oil	0.050-mm-layer	20	T	0.46	2
Oil, Lubricating Oil	0.125-mm-layer	20	T	0.72	2
Oil, Lubricating Oil	thick layer	20	T	0.82	2
Oil, Lubricating Oil	layer on Ni-basis, only Ni-basis	20	T	0.05	2
Paint	3 colors, sprayed on aluminium	70	LW	0.92–0.94	9
Paint	4 colors, sprayed on aluminium	70	SW	0.50–0.53	9
Paint	aluminium on harshened surface	20	T	0.4	1
Paint	bakelite	80	T	0.83	1
Paint	heat-proof	100	T	0.92	1
Paint	black, shiny, sprayed on iron	20	T	0.87	1
Paint	black, dull	100	T	0.97	2
Paint	black, dull	40–100	T	0.96–0.98	1
Paint	white	40–100	T	0.8–0.95	1
Paint	white	100	T	0.92	2
Paper	4 different colors	70	LW	0.92–0.94	9
Paper	4 different colors	70	SW	0.68–0.74	9
Paper	coated with black paint		T	0.93	1
Paper	dark blue		T	0.84	1
Paper	yellow		T	0.72	1
Paper	green		T	0.85	1
Paper	red		T	0.76	1
Paper	black		T	0.9	1
Paper	black, blunt		T	0.94	1
Paper	black, blunt	70	LW	0.89	9
Paper	black, blunt	70	SW	0.86	9
Paper	white	20	T	0.7–0.9	1
Paper	white, 3 different shiny coatings	70	LW	0.88–0.90	9
Paper	white, 3 different shiny coatings	70	SW	0.76–0.78	9
Paper	white, bonded	20	T	0.93	2
Plastics	fiber optics laminate (printed circuit board)	70	LW	0.91	9
Plastics	fiber optics laminate (printed circuit board)	70	SW	0.94	9
Plastics	polyurethane-insulating plate	70	LW	0.55	9
Plastics	polyurethane-insulating plate	70	SW	0.29	9

# Appendix: Emissivity Table

Material	Specification	Temperature in °C	Spectrum	Emissivity	R
Plastics	PVC, plastic floor, blunt, structured	70	LW	0.93	9
Plastics	PVC, plastic floor, blunt, structured	70	SW	0.94	9
plate	shiny	20–50	T	0.04–0.06	1
plate	white plate	100	T	0.07	2
Platinum		17	T	0.016	4
Platinum		22	T	0.05	4
Platinum		260	T	0.06	4
Platinum		538	T	0.1	4
Platinum		1000–1500	T	0.14–0.18	1
Platinum		1094	T	0.18	4
Platinum	band	900–1100	T	0.12–0.17	1
Platinum	wire	50–200	T	0.06–0.07	1
Platinum	wire	500–1000	T	0.10–0.16	1
Platinum	wire	1400	T	0.18	1
Platinum	clean, polished	200–600	T	0.05–0.10	1
plumb	shiny	250	T	0.08	1
plumb	non oxidized, polished	100	T	0.05	4
plumb	oxidized, grey	20	T	0.28	1
plumb	oxidized, grey	22	T	0.28	4
plumb	oxidized at 200 °C	200	T	0.63	1
plumb, red		100	T	0.93	4
plumb, red, powder		100	T	0.93	1
Polystyrene	heat insulation	37	SW	0.6	7
Porcelain	glazed	20	T	0.92	1
Porcelain	white, glowing		T	0.70–0.75	1
Rubber	hard	20	T	0.95	1
Rubber	soft, grey, harshened	20	T	0.95	1
Sand			T	0.6	1
Sand		20	T	0.9	2
Sandpaper	coarse	80	T	0.85	1
Sandstone	polished	19	LLW	0.909	8
Sandstone	harshened	19	LLW	0.935	8
Silver	polished	100	T	0.03	2
Silver	clean, polished	200–600	T	0.02–0.03	1
Skin	Human Being	32	T	0.98	2
Slag	basin	0–100	T	0.97–0.93	1
Slag	basin	200–500	T	0.89–0.78	1
Slag	basin	600–1200	T	0.76–0.70	1
Slag	basin	1400–1800	T	0.69–0.67	1
Snow:	see water				
Stainless steel	plate, polished	70	LW	0.14	9
Stainless steel	plate, polished		SW	0.18	9
Stainless steel	plate, not treated, scratched	70	LW	0.28	9
Stainless steel	plate, not treated, scratched	70	SW	0.3	9
Stainless steel	milled	700	T	0.45	1
Stainless steel	alloy, 8 % Ni, 18 % Cr	500	T	0.35	1

Material	Specification	Temperature in °C	Spectrum	Emissivity	R
Stainless steel	sandblasted	700	T	0.7	1
Stainless steel	type 18–8, shiny	20	T	0.16	2
Stainless steel	type 18–8, oxidized at 800 °C	60	T	0.85	2
Stucco	harshened, yellow green	90	T	0.91	1
Tar			T	0.79–0.84	1
Tar	paper	20	T	0.91–0.93	1
Titanium	oxidized at 540 °C	200	T	0.4	1
Titanium	oxidized at 540 °C	500	T	0.5	1
Titanium	oxidized at 540 °C	1000	T	0.6	1
Titanium	polished	200	T	0.15	1
Titanium	polished	500	T	0.2	1
Titanium	polished	1000	T	0.36	1
Tungsten		200	T	0.05	1
Tungsten		600–1000	T	0.1–0.16	1
Tungsten		1500–2200	T	0.24–0.31	1
Tungsten	twine	3300	T	0.39	1
Varnish	on parquet flooring made of oak	70	LW	0.90–0.93	9
Varnish	on parquet flooring made of oak	70	SW	0.9	9
Varnish	dull	20	SW	0.93	6
Vulcanite			T	0.89	1
Wall Paper	slightly patterned, light grey	20	SW	0.85	6
Wall Paper	slightly patterned, red	20	SW	0.9	6
Water	distilled	20	T	0.96	2
Water	ice, strongly covered with frost	0	T	0.98	1
Water	ice, slippery	–10	T	0.96	2
Water	ice, slippery	0	T	0.97	1
Water	frost crystals	–10	T	0.98	2
Water	coated >0.1 mm thick	0–100	T	0.95–0.98	1
Water	snow		T	0.8	1
Water	snow	–10	T	0.85	2
Wood		17	SW	0.98	5
Wood		19	LLW	0.962	8
Wood	planed	20	T	0.8–0.9	1
Wood	planed oak	20	T	0.9	2
Wood	planed oak	70	LW	0.88	9
Wood	planed oak	70	SW	0.77	9
Wood	treated with sandpaper		T	0.5–0.7	1
Wood	pine, 4 different samples	70	LW	0.81–0.89	9
Wood	pine, 4 different samples	70	SW	0.67–0.75	9
Wood	plywood, even, dry	36	SW	0.82	7
Wood	plywood, untreated	20	SW	0.83	6
Wood	white, damp	20	T	0.7–0.8	1
Zinc	plate	50	T	0.2	1
Zinc	oxidized at 400 °C	400	T	0.11	1
Zinc	oxidized surface	1000–1200	T	0.50–0.60	1
Zinc	polished	200–300	T	0.04–0.05	1

## Selection Criteria for Infrared Thermometers

A wide selection of infrared sensors is available for non-contact temperature measurement. The following criteria will help to find the optimal measuring device for your application:

- Initial question
- Temperature range
- Environmental conditions
- Spot size
- Material and surface of the measuring object
- Response time of the infrared thermometer
- Interface

### Initial question

The basic question is: point measurement or surface measurement? Based on the aim of application, the use of either an infrared thermometer or an infrared camera is possible. Once this is established, the product must be specified. In exceptional cases, there are also applications where both technologies would make sense; in this situation, we recommend consulting the relevant application engineers.

### Temperature Range

Choose the temperature range of the sensor as optimal as possible in order to reach a high resolution of the object temperature. The measuring ranges can be adjusted to the measuring task manually or via digital interface.

### Environmental Conditions

The maximum acceptable ambient temperature of the sensors is very important. The optris® CT line operates in up to 250 °C without any cooling. By using water and air cooling the measuring devices work in even higher ambient temperatures. Air purge systems help to keep the optics clean from additional dust in the atmosphere.

### Spot Size

The size of the measuring object has to be equal to or bigger than the viewing field of the sensor in order to reach accurate results. The spot diameter (S) changes accordingly to the distance of the sensor (D). The brochures specify the D:S relation for the different optics.

Further information is available on our online spot size calculator:  
[www.optris.com/spot-size-calculator](http://www.optris.com/spot-size-calculator)

## Material and Surface of the Measuring Object

The emissivity depends on material, surface and other factors. The common rule reads as follows: The higher the emissivity, the easier the measurement generates a precise result. Many infrared sensors offer the adjustment of the emissivity. The appropriate values can be taken from the tables in the appendix.

## Response Time of Infrared Thermometers

The response time of infrared sensors is very small compared to contact thermometers. They range between 1 ms to 250 ms, strongly depending on the detector of the device. Because of the detector the response time is limited in the lower range. The electronics help to correct and adjust the response time according to the application (e.g. averaging or maximum hold).

## Interfaces for the Signal Output

The interface supports the analysis of the measuring results. The following interfaces are available:

- Output/alarm: 0/4 – 20 mA
- Output/analog: 0 – 10 mV
- Thermocouple: Type J, Type K
- Interfaces: CAN, Profibus-DP, RS232, RS485, USB, Relais, Ethernet (PI)



You can find an overview of the technical data of all Optris products in our product brochure:

[www.optris.com/optris-downloads](http://www.optris.com/optris-downloads)

innovative infrared technology

Optris GmbH  
Ferdinand-Buisson-Str. 14  
13127 Berlin · Germany  
Phone: +49 (0)30 500 197-0  
Fax: +49 (0)30 500 197-10  
E-Mail: [sales@optris.com](mailto:sales@optris.com)  
[www.optris.com](http://www.optris.com)